

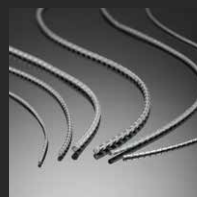

# EXCELLENCE BY DESIGN

CELEBRATING 40 YEARS OF INSPIRATION IN EMI GASKETS

## EMI Gaskets & Shielding Products Catalog & Design Guide

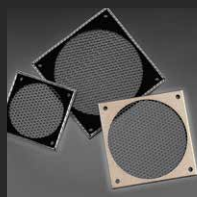
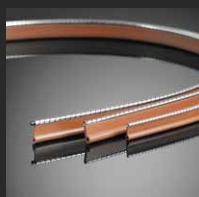

[www.spira-emi.com](http://www.spira-emi.com) • (818) 764-8222 • [info@spira-emi.com](mailto:info@spira-emi.com)

# EMI Gaskets & Shielding Products Catalog & Design Guide

Spira Manufacturing Corporation has been serving the EMC community with quality engineered Electromagnetic Interference (EMI) and Radio-Frequency Interference (RFI) shielding products since 1978.

We proudly offer the finest and most reliable EMI/RFI shielding gaskets and honeycomb filters on the market, at very competitive prices. The strength of Spira lies in our exceptional products, on-time delivery, superior customer service, and technical support.

Spira was founded by George Kunkel, an EMI/EMC design engineer, who was frustrated with the problems he encountered with EMI gaskets that were commercially available for EMI/RFI shielding applications. To best address his and the industry's needs, he designed and patented the spiral EMI gasket and developed a whole family of exceptional EMI products. EMI Educational seminars and papers are available at [www.spira-emi.com/education](http://www.spira-emi.com/education).

Spira is committed to manufacturing quality products to ensure that you, the customer, will be able to make an informed decision and choose the best gasket for your design. Each product manufactured by Spira fills a very specific need in the market, not found in any other EMI gasket.

Spira's commitment to quality is demonstrated through our **ISO-9001** and **AS9100** quality certifications. Our products also meet requirements of ITAR, RoHS, DFAR, and others. For more information, please visit [www.spira-emi.com/compliance](http://www.spira-emi.com/compliance).

Visit our website:

**[WWW.SPIRA-EMI.COM](http://WWW.SPIRA-EMI.COM)**

Get new & updated technical  
information, join our mailing list,  
& request free samples!

The newest version of this Catalog &  
Design Guide can be downloaded at:

**[WWW.SPIRA-EMI.COM/CATALOG](http://WWW.SPIRA-EMI.COM/CATALOG)**



Rev 5-23-22

**Spira Manufacturing Corporation**  
650 Jessie Street, San Fernando, CA 91340  
Phone: (818) 764-8222, Fax: (818) 764-9880  
E-mail: [sales@spira-emi.com](mailto:sales@spira-emi.com) or [techsupport@spira-emi.com](mailto:techsupport@spira-emi.com)  
**WWW.SPIRA-EMI.COM**

# Table Of Contents

## Groove Mounted EMI Gaskets

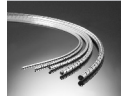

**Spira-Shield** ..... 1  
Excellent shielding (up to 160 dB), groove mounted product. Tin plated Beryllium Copper. Edge plated version has excellent resistance to salt-fog environments.



**Quick-Shield** ..... 3  
Moderate shielding, low cost, groove mounted. Stainless Steel.  
Superior salt-fog resistance (>1000 hours) against nickel plated surfaces.



**Ultra Quick-Shield** ..... 5  
Excellent shielding (up to 160 dB), low cost, groove mounted.  
Tin plated Stainless Steel.

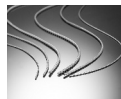

**Flexi-Shield** ..... 7  
High to moderate EMI and rain/wind/dust sealing, low cost, groove mounted. Ideal for sliding, VME, and compact PCI applications.

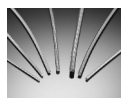

**Enduro-Shield** ..... 9  
Our most durable gasket, high EMI and rain/wind/dust sealing, groove mounted. Ideal for sliding applications.



**O-Rings: Enduro-Shield & Flexi-Shield** ..... 11  
Standard "AS" series size o-rings, excellent EMI and rain/wind/dust sealing. Enduro-Shield O-Rings are extremely durable.



**"D" Multi-Seal** ..... 13  
Our best groove mounted EMI & environmental (one atmosphere) seal.

## Surface Mounted EMI Gaskets

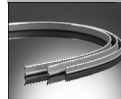

**Basic Multi-Seal** ..... 15  
Our best surface mounted EMI & environmental (one atmosphere) seal.



**Quick-Strip** ..... 17  
Moderate to excellent shielding, surface mounted, environmental seal.  
"Peel-n-Stick" adhesive backing.

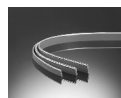

**Spira-Strip** ..... 19  
Excellent shielding (up to 160 dB), surface mounted product.  
Can provide excellent environmental sealing.



**Environmental-Only Connector-Seal** ..... 21  
Highly reliable & reusable environmental sealing for flange mounted connectors. Silicone or Fluorosilicone rubber sealed over a corrosion resistant metal frame.



**EMI & Environmental Connector-Seal** ..... 23 & 25  
Excellent EMI & environmental sealing for flange mounted connectors. Standard-Mount and Front-Mount versions.



**EMI-Only Connector-Seal** ..... 27  
Excellent EMI-only shielding for flange-mounted connectors.

## Other Products

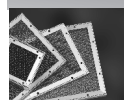

**Shielded Air Vent Honeycomb Filters** . . . . . 29  
 Cost Effective Shielded Air Vent Filters providing excellent levels of shielding (up to 140 dB).

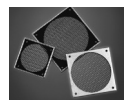

**Shielded Honeycomb Fan Filters** . . . . . 35  
 High and reliable levels of shielding at very cost effective prices.  
 Compatible with 38, 40, 60, 80, 92 and 120mm fans.



**Dovetail Groove Cutters** . . . . . 36  
 Specially designed to cut the recommended dovetail groove.



**Custom Gaskets** . . . . . 37  
 Custom O-Rings, Framed Gaskets, Die Cuts and custom Honeycomb Filter combinations.



**Z<sub>T</sub> Test Fixture** . . . . . 39  
 Reliable, low cost transfer impedance test fixture for accurate testing of EMI gaskets and gasketed joints per SAE, ARP-1705.

## Application Information

**Shielding Theory** . . . . . 43  
 The basics of EMI shielding theory.

**Shielding Quality** . . . . . 47  
 Graphs illustrating shielding levels.

**Groove Mounting Techniques** . . . . . 51  
 Recommendations for groove mounting.

**Surface Mounting Techniques** . . . . . 55  
 Recommendations for surface mounting.

**Fastener Spacing** . . . . . 56  
 Formulas to calculate fastener spacing.

**Material Specifications** . . . . . 59  
 Applicable component specifications.

**Material Compatibility** . . . . . 60  
 Joint surface compatibility chart for corrosion control.  
 RoHS compliance information.

**Part Numbers** . . . . . 61  
 A matrix of Spira products and part numbers.

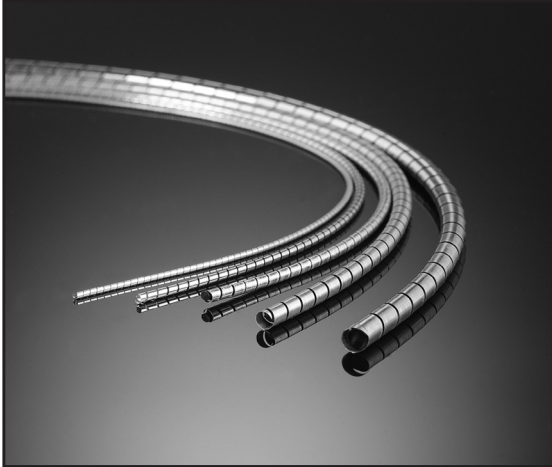

The Spira-Shield patented spiral is the basis for all of our unique high shielding EMI gasketing solutions. The spiral is wound out of spring temper beryllium copper for excellent spring memory and compression set resistance. The spiral is tin plated for superior conductivity and shielding properties. The edge plated version exhibits excellent corrosion resistance against aluminum when exposed to humid or salt-fog environments.

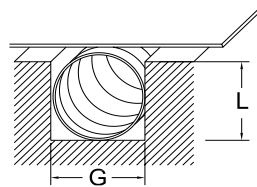

standard o-ring groove

See page 51 for groove mounting techniques.

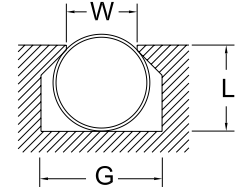

dovetail groove

Spira-Shield Part Numbers (Tin/Lead Plated Beryllium Copper)				Recommended Groove Dimensions		
Diameter	Standard Force*	Moderate Force	Low Force	Depth (L) +.002"-.000"	Width (G) +.007"-.005"	Width (W) +.000"-.002"
.034" ± .002"	SS-02	MS-02 NC**	--	.023"	.046"	.033"
.047" ± .002"	SS-03	MS-03 NC**	--	.035"	.063"	.045"
.063" ± .003"	SS-04	MS-04	LS-04	.046"	.094"	.060"
.070" ± .003"	SS-.070	MS-.070	LS-.070	.053"	.094"	.067"
.078" ± .003"	SS-05	MS-05	LS-05	.059"	.109"	.075"
.094" ± .004"	SS-06	MS-06	LS-06	.070"	.125"	.090"
.103" ± .004"	SS-.103	MS-.103	LS-.103	.077"	.141"	.099"
.109" ± .004"	SS-07	MS-07	LS-07	.082"	.156"	.105"
.125" ± .004"	SS-08	MS-08	LS-08	.094"	.171"	.121"
.139" ± .005"	SS-.139	MS-.139	LS-.139	.104"	.187"	.134"
.141" ± .005"	SS-09	MS-09	LS-09	.105"	.187"	.136"
.172" ± .005"	SS-11	MS-11	LS-11	.128"	.234"	.165"
.187" ± .006"	SS-12	MS-12	LS-12	.140"	.250"	.181"
.250" ± .007"	SS-16	MS-16	LS-16	.185"	.343"	.240"
.312" ± .009"	SS-20	MS-20	LS-20	.234"	.422"	.300"
.375" ± .011"	SS-24	MS-24	LS-24	.280"	.500"	.364"
.500" ± .015"	--	MS-32	LS-32	.375"	.656"	.485"

Moderate and low force gaskets come with a cord unless specified otherwise. (See Options).

\* All standard force gaskets come without a cord. \*\* These sizes cannot be ordered with a cord.

See page 51 for groove mounting techniques.

Dovetail Groove Cutters detailed on page 36.

## Application Information

This high-shielding gasket is well known for solving shielding problems that no other gasket can solve, and is perfect for military and aerospace projects. However, the cost is competitive enough that this gasket is also perfect for many commercial applications that require high-shielding.

### Materials

See page 59 for material specifications.

**Spiral:** Tin/lead plated beryllium copper. (See Options for RoHS compliance).  
Electroplated, 90% tin, 10% lead (edges unplated).

**Cord:** 80 durometer PVC (hard plastic) optional, may require additional lead time.



## Shielding Quality

This gasket offers shielding quality up to 165 dB. The shielding quality may vary depending on your specific application. Refer to page 48 for more complete performance data.

## Compression Force

Spira-Shield gaskets come in three different resiliencies (as shown below). Optimal compression of the gasket is 25% of the diameter of the spiral. Since the force to compress the gasket is a function of the cube of the thickness of the beryllium copper ribbon, the compression forces shown are approximate.

**Standard Force:** ~30 pounds per linear inch compression.

**Moderate Force:** ~10 pounds per linear inch compression.

**Low Force:** ~1.5 pounds per linear inch compression.

## Mounting

This gasket is groove mounted. See page 51 for detailed mounting information.

## Available Options

### Custom Sizes

We can manufacture Spira-Shield gaskets in any size diameter, from .034" up to approximately 1.5". The functional length of the part may be small at very large diameters. Please contact us with your requirements.

### Plating

*Specify plating by choosing the desired prefix from the table.*

*Example:  
EIWLS-12  
RoHS edge tin plated  
Low Force*

Plating options can be specified by adding a prefix before the part number:

**E:** Edge tin/lead plating (includes edges) for high humidity or salt-fog environments

**IW:** RoHS compliant tin plating (Example: **IWMS-08**)

**EIW:** RoHS compliant edge tin plating for high humidity or salt-fog

Material	Force	Tin/lead Plating	RoHS Tin	Edge Tin/Lead	RoHS Edge Tin
Beryllium Copper	Standard	SS (default)	IWSS	ESS	EIWSS
	Moderate	MS	IWMS	EMS	EIWMS
	Low	LS	IWLS	ELS	EIWLS

*See page 60 for material compatibility information.*

Additional plating options are available by special request including: Reflow edge tin plating (R), Gold (G) and Sulfamate Nickel (N).

### Cord Insert

Moderate and low force gaskets come standard with PVC cord. The cord acts as a mechanical stop to protect the spiral from over-compression during use and handling. Specify "no cord" in the moderate and low force gaskets as follows:

**NC:** No Cord (Example: **MS-08 NC**)

All Standard Force gaskets come without cord (no NC required).

### Special Cord

Special cords can be specified as follows (may not be available in all sizes and may include extra charges):

**-F:** Solid Fluorosilicone Cord (Example: **MS-08-F**)

**-O:** Space Qualified Silicone (non-outgassing)

**-S:** Solid Silicone Cord

**-T:** Thermal Plastic Rubber Cord

## Ordering Information

Spira-Shield is sold by the foot and typically packaged on spools except in small quantities. It can also be ordered cut-to-length in specific sizes or you can cut it yourself using a sharp pair of scissors. Not all configurations are stock items. Contact us for availability. Custom o-rings are also available as described on page 37.

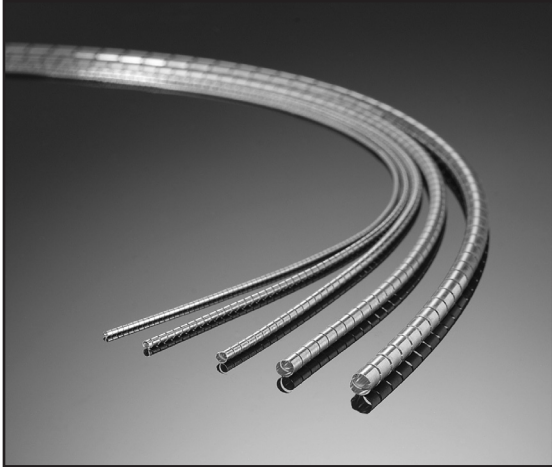

This patented spiral is the best *low cost* EMI gasket solution. The spiral is wound out of spring temper stainless steel for excellent spring memory and compression set resistance. The stainless steel spiral exhibits moderate to high shielding properties at a very low cost.

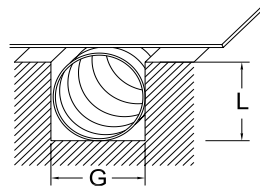

standard o-ring groove

See page 51 for groove mounting techniques.

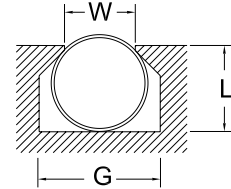

dovetail groove

Quick-Shield Part Numbers (Stainless Steel)				Recommended Groove Dimensions		
Diameter	Standard Force*	Moderate Force	Low Force	Depth (L) +.002"-.000"	Width (G) +.007"-.005"	Width (W) +.000"-.002"
.034" ± .002"	NI-02	--	--	.023"	.046"	.033"
.047" ± .002"	NI-03	NM-03 NC**	--	.035"	.063"	.045"
.063" ± .003"	NI-04	NM-04 NC	NL-04 NC	.046"	.094"	.060"
.070" ± .003"	NI-.070	NM-.070 NC	NL-.070 NC	.053"	.094"	.067"
.078" ± .003"	NI-05	NM-05 NC	NL-05 NC	.059"	.109"	.075"
.094" ± .004"	NI-06	NM-06 NC	NL-06 NC	.070"	.125"	.090"
.103" ± .004"	NI-.103	NM-.103 NC	NL-.103 NC	.077"	.141"	.099"
.109" ± .004"	NI-07	NM-07 NC	NL-07 NC	.082"	.156"	.105"
.125" ± .004"	NI-08	NM-08 NC	NL-08 NC	.094"	.171"	.121"
.139" ± .005"	NI-.139	NM-.139 NC	NL-.139 NC	.104"	.187"	.134"
.141" ± .005"	NI-09	NM-09 NC	NL-09 NC	.105"	.187"	.136"
.172" ± .005"	NI-11	NM-11 NC	NL-11 NC	.128"	.234"	.165"
.187" ± .006"	NI-12	NM-12 NC	NL-12 NC	.140"	.250"	.181"
.250" ± .007"	NI-16	NM-16 NC	NL-16 NC	.185"	.343"	.240"
.312" ± .009"	NI-20	NM-20 NC	NL-20 NC	.234"	.422"	.300"

Moderate and low force gaskets may be ordered with cord insert. (See Options).

\* All standard force gaskets come without a cord. \*\* These sizes cannot be ordered with a cord.

See page 51 for groove mounting techniques.

Dovetail Groove Cutters detailed on page 36.

## Application Information

The low cost and moderate shielding of this gasket offer an excellent solution for meeting FCC and European Community EMI requirements. Combining it with a die-cast or molded "pinch boss" groove gives you the optimal price/performance combination. See page 53 for more details.

### Materials

See page 59 for material specifications.

**Spiral:** Stainless steel.

**Cord:** "No cord" is the default to keep costs low. See Options if cord is desired.

**Shielding Quality** This gasket offers shielding quality in excess of 95 dB at 1 GHz. The shielding quality may vary depending on the specific application. Refer to page 49 for more complete performance data.

**Compression Force** Quick-Shield gaskets come in three different resiliencies (as shown below). Optimal compression of the gasket is 25% of the diameter of the spiral. Since the force to compress the gasket is a function of the cube of the thickness of the stainless steel ribbon, the compression forces shown are approximate.

**Standard Force:** ~30 pounds per linear inch compression.

**Moderate Force:** ~10 pounds per linear inch compression.

**Low Force:** ~1.5 pounds per linear inch compression.

**Mounting** This gasket is groove mounted.

## Available Options

**Cord Insert** If over-compression of the gasket is a concern or problem, remove the “NC” from the part number on the moderate and low force series gaskets to request cord.

Example: **NM-06 NC** will come without a cord. **NM-06** will include cord.

All Standard Force gaskets come without cord (no NC required).

**Custom Sizes** We can manufacture Quick-Shield gaskets in any size diameter, from .034” up to approximately 1.5”. The functional length of the part may be short at very large diameters. Please contact us with your requirements.

**Plating** For plating options, see pages 5-6 for *Ultra* Quick-Shield.

## Ordering Information

Quick-Shield is sold by the foot and typically packaged on spools except in small quantities. It can also be ordered cut-to-length in specific sizes at a low cost, or you can cut it yourself using a sharp pair of scissors. Not all configurations are stock items. Contact us for availability. Custom o-rings are also available as described on page 37.

## Groove Mounted Gasket Matrix

This matrix lists Spira’s various **groove mounted** gaskets. See product pages for more information.

Product	Shielding	Base Material	Plating	Application Notes
<b>Spira-Shield</b>	Excellent EMI	Beryllium Copper	Tin/Lead, RoHS Tin or other	Best EMI Shielding, Salt-Fog Option*
<b>Ultra Quick-Shield</b>	Excellent EMI	Stainless Steel	Tin/Lead or RoHS Tin	Lower Cost Commercial Option
<b>Quick-Shield</b>	Moderate EMI	Stainless Steel	None	Lowest Cost, Salt Fog*
<b>Flexi-Shield</b>	High to Moderate EMI Rain/Wind/Dust	Beryllium Copper or Stainless Steel	Tin/Lead, RoHS Tin or other	Rain/Wind/Dust, Highest Resiliency, Low Cost Sliding, Lowest Compression Force
<b>Enduro-Shield</b>	High to Excellent EMI Rain/Wind/Dust	Beryllium Copper or Stainless Steel	Tin/Lead, RoHS Tin or other	Rain/Wind/Dust, Sliding, Extremely Durable Nearly Indestructible
<b>“D” Multi-Seal</b>	High to Excellent EMI True Environmental Seal	Beryllium Copper or Stainless Steel	Tin/Lead, RoHS Tin or other	Groove-Mounted EMI & True Environmental Seal

\* See page 60 for material compatibility information.



# Ultra Quick-Shield

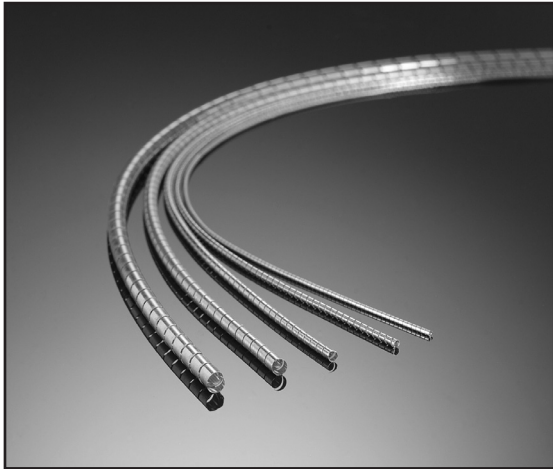

Ultra Quick-Shield offers excellent shielding at an affordable price. The spiral is wound out of low cost spring temper stainless steel for excellent spring memory and compression set resistance. The spiral is tin plated for superior conductivity and shielding properties.

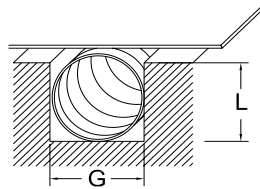

standard o-ring groove

See page 51 for groove mounting techniques.

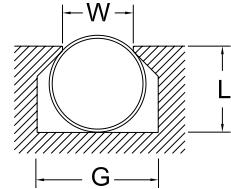

dovetail groove

Ultra Quick-Shield Part Numbers (Tin Plated Stainless Steel)				Recommended Groove Dimensions		
Diameter	Standard Force*	Moderate Force	Low Force	Depth (L) +.002"-.000"	Width (G) +.007"-.005"	Width (W) +.000"-.002"
.034" ± .002"	TNI-02	TNM-02 NC**/**	--	.023"	.046"	.033"
.047" ± .002"	TNI-03	TNM-03 NC**/**	--	.035"	.063"	.045"
.063" ± .003"	TNI-04	TNM-04 NC	TNL-04 NC***	.046"	.094"	.060"
.070" ± .003"	TNI-.070	TNM-.070 NC	TNL-.070 NC	.053"	.094"	.067"
.078" ± .003"	TNI-05	TNM-05 NC	TNL-05 NC***	.059"	.109"	.075"
.094" ± .004"	TNI-06	TNM-06 NC	TNL-06 NC***	.070"	.125"	.090"
.103" ± .004"	TNI-.103	TNM-.103 NC	TNL-.103 NC***	.077"	.141"	.099"
.109" ± .004"	TNI-07***	TNM-07 NC	TNL-07 NC	.082"	.156"	.105"
.125" ± .004"	TNI-08***	TNM-08 NC	TNL-08 NC	.094"	.171"	.121"
.139" ± .005"	TNI-.139	TNM-.139 NC	TNL-.139 NC	.104"	.187"	.134"
.141" ± .005"	TNI-09	TNM-09 NC	TNL-09 NC	.105"	.187"	.136"
.172" ± .005"	TNI-11	TNM-11 NC	TNL-11 NC	.128"	.234"	.165"
.187" ± .006"	TNI-12***	TNM-12 NC***	TNL-12 NC	.140"	.250"	.181"
.250" ± .007"	TNI-16***	TNM-16 NC	TNL-16 NC	.185"	.343"	.240"
.312" ± .009"	TNI-20***	TNM-20 NC***	TNL-20 NC	.234"	.422"	.300"

Moderate and low force gaskets may be ordered with cord insert. (See Options).

\* All standard force gaskets come without a cord.

\*\* These sizes cannot be ordered with a cord.

\*\*\* These sizes are non-stock items and may include additional plating fees.

See page 51 for groove mounting techniques.

Dovetail Groove Cutters detailed on page 36.

## Application Information

The affordable cost and superior shielding of this gasket makes it an excellent choice for high end commercial applications. Combining it with a die-cast or molded "pinch boss" groove gives you the optimal price/performance combination. See page 53 for more information.

## Materials

See page 59 for material specifications.

Spiral: Tin/lead plated stainless steel. (See Options for RoHS compliance).  
Electroplated, 90% tin, 10% lead (edges unplated).

## Shielding Quality

These gaskets can offer shielding quality in excess of 150 dB at frequencies between 100 kHz and 1 GHz. The shielding quality may vary depending on the specific application. Refer to page 49 for complete performance data.

## Compression Force

Ultra Quick-Shield gaskets come in three different resiliencies (as shown below). Optimal compression of the gasket is 25% of the diameter of the spiral. Since the force to compress the gasket is a function of the cube of the thickness of the stainless steel ribbon, the compression forces shown are approximate.

**Standard Force:** ~30 pounds per linear inch compression.

**Moderate Force:** ~10 pounds per linear inch compression.

**Low Force:** ~1.5 pounds per linear inch compression.

## Mounting

This gasket is groove mounted.

## Available Options

### Plating

See page 60 for material compatibility information.

To specify tin plating for RoHS compliance, replace the "T" with "IW" at the beginning of the part number. Additional plating charges may apply.

**IW:** RoHS compliant tin plating (Example: **IWNL-06 NC**)

Material	Force	No Plating	Tin/lead Plating	RoHS Tin Plating	Edge Tin Plating
Stainless Steel	Standard	See Quick-Shield page 3	TNI (default)	IWNI	See Spira-Shield page 1
	Moderate		TNM	IWNM	
	Low		TNL	IWNL	

This gasket is not recommended for high humidity or salt-fog applications because the edges of the gasket are not plated. If high humidity or salt-fog environments are to be encountered, the edge plated version of our Spira-Shield gasket is recommended.

### Cord Insert

To keep costs low, we recommend you omit the cord usually used in the spiral. However, if over-compression of the gasket is a concern or problem, remove the "NC" from the part number on the moderate and low force series gaskets.

Example: **TNL-06 NC** will come without a cord. **TNL-06** will include cord.

All Standard Force gaskets come without cord (no NC required).

### Custom Sizes

We can manufacture Ultra Quick-Shield gaskets in any size diameter, from .034" up to approximately 1.5". The functional length of the part may be short at very large diameters. Please contact us with your requirements.

## Ordering Information

Ultra Quick-Shield is sold by the foot and typically packaged on spools except in small quantities. It can also be ordered cut-to-length in specific sizes at a low cost, or you can cut it yourself using a sharp pair of scissors. Not all configurations are stock items. Contact us for availability. Custom o-rings are also available as described on page 37.

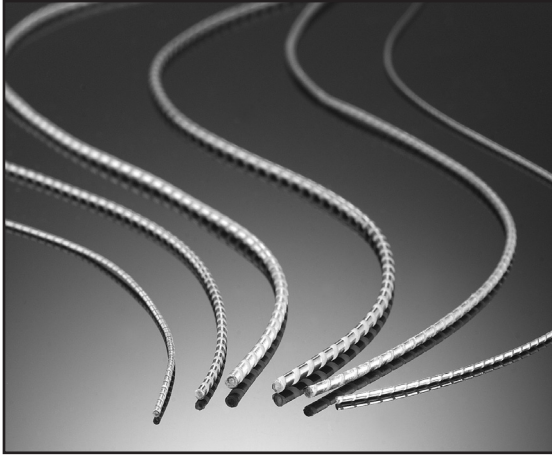

Spira's Flexi-Shield gasket offers the best of both worlds! This gasket combines the EMI shielding performance of our other spiral gaskets with the rain/wind/dust sealing of an elastomer! A special process wraps our highly conductive spiral around a soft silicone tube. This results in gaskets that are very easy to handle, are rugged enough to be used in demanding sliding applications, provide as little as two pounds of closure force per inch, and offer moderate to high shielding, depending on the materials chosen. The low force series is especially well-suited to shielding the front/rear panels of VME/VXI and similar enclosures.

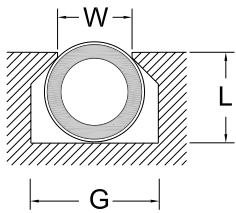

Flexi-Shield mounted in dovetail groove.

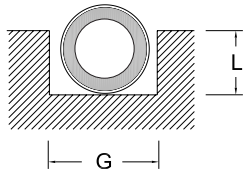

Flexi-Shield mounted in standard o-ring groove.

Flexi-Shield Part Numbers (Stainless Steel)				Recommended Groove Dimensions*		
Diameter	Standard Force	Moderate Force	Low Force	Depth (L) +.002"- .000"	Width (G) +.007"- .005"	Width (W) +.000"- .002"
.063" ± .003"	SQ-04	MQ-04	LQ-04	.046"	.094"	.060"
.070" ± .003"	SQ-.070	MQ-.070	LQ-.070	.053"	.094"	.067"
.094" ± .004"	SQ-06	MQ-06	LQ-06	.070"	.125"	.090"
.103" ± .004"	SQ-.103	MQ-.103	LQ-.103	.077"	.141"	.099"
.106" ± .004"	SQ-.106	MQ-.106	LQ-.106	.080"	.141"	.102"
.125" ± .004"	SQ-08	MQ-08	LQ-08	.094"	.171"	.121"
.139" ± .005"	SQ-.139	MQ-.139	LQ-.139	.104"	.187"	.134"
.141" ± .005"	SQ-09	MQ-09	LQ-09	.105"	.187"	.136"
.187" ± .008"	SQ-12	MQ-12	LQ-12	.140"	.250"	.181"
.250" ± .010"	SQ-16	MQ-16	LQ-16	.185"	.343"	.240"

\* Different groove required for VME/VXI and similar front/rear panel shielding. Refer to our VME/VXI Shielding Design Guide on our website for details.

See page 51 for groove mounting techniques.

Dovetail Groove Cutters detailed on page 36.

Note: Larger sizes may be available. Contact us for more information.

## Application Information

Whether you need moderate to high shielding levels, rain/wind/dust sealing, or simply want the ease of handling that the inner tube provides, Spira's Flexi-Shield comes through for you. All the benefits for one low cost!

### Shielding Quality

We offer stainless steel for moderate shielding quality, and optional tin plating for higher shielding levels. All shielding quality results are based on tests against tin plated joint surfaces. The shielding quality may vary depending on your specific application. Refer to page 50 for more complete data.

**Stainless Steel (All Forces):** 100 dB at 1 GHz

**Low Force Tin Plated Gaskets:** 120 dB at 1 GHz

**Moderate and Standard Force Tin Plated Gaskets:** 130 dB at 1 GHz

### Low Closure Force

The low force series is ideal for applications with very little closure force (approximately two pounds per linear inch compression). The gasket resists compression set, is very easy to handle and will provide a rain/wind/dust seal.



## VME/VXI and Similar Front/Rear Panels

The low force gasket is the best choice for shielding front and back panels of VME/VXI and similar enclosures. The gaskets are easy to insert and testing shows no visible wear after 1,000 insertions! Flexi-Shield gaskets are manufactured from a continuous piece of metal, so they have no small pieces to break off and short out equipment. For specific design information, refer to our *VME/VXI Shielding Design Guide*.

## Sliding Applications

All versions of Flexi-Shield are ideally suited for sliding applications. Specify moderate or standard force Flexi-Shield where extreme durability is required.

## Materials

**Spiral:** Stainless steel (tin plating optional).  
**Inner Tubing:** 60 durometer silicone.

## Environmental Sealing

Our testing shows that all sizes and all resiliencies offer a rain/wind/dust seal. (We have other gaskets that provide an immersion seal). Contact us for free samples to determine if this gasket meets your environmental sealing needs!

## Compression Force

Flexi-Shield gaskets come in three different resiliencies (as shown below). Optimal compression of the gasket is 25% of the diameter of the spiral (except in the case of VME/VXI designs. Please refer to our *VME/VXI Shielding Design Guide*). Since the force to compress the gasket is a function of the cube of the thickness of the stainless steel ribbon, the compression forces shown are approximate.

**Standard Force:** ~30 pounds per linear inch compression.

**Moderate Force:** ~10 pounds per linear inch compression.

**Low Force:** ~2 pounds per linear inch compression.

## Mounting

Refer to Groove Mounting Techniques for detailed mounting information. Refer to our *VME/VXI Shielding Design Guide* on our website for more information.

## Available Options

### Materials & Plating

See pages 59-60 for material specifications & compatibility information.

Plating for stainless steel Flexi-Shield can be specified using the following prefix:

**T:** Tin/lead plating over the stainless steel for better shielding quality

Electroplated 90% tin, 10% lead (Example: **TSQ-04**)

**IW:** RoHS compliant tin plating (Example: **IWSQ-04**)

Tin plated beryllium copper material may be substituted if desired. An edge plated version is also available for high humidity/salt-fog environments as shown below.

Specify material by choosing the desired prefix from the table.

Example:  
**EIWM-08**  
RoHS edge tin plated beryllium copper  
Moderate Force

Material	Force	No Plating	Tin/lead Plating	RoHS Tin	Edge Tin/Lead	RoHS Edge Tin
Stainless Steel	Standard	SQ (default) MQ LQ	TSQ	IWSQ	--	--
	Moderate		TMQ	IWMQ		
	Low		TLQ	IWLQ		
Beryllium Copper	Standard	--	ST	IWST	EST	EIWST
	Moderate		MT	IWMT	EMT	EIWMT
	Low		LT	IWLT	ELT	EIWLT

## Special Tubing

Fluorosilicone tubing can be specified as follows (may include extra charges):

**-F:** Fluorosilicone tubing (Example: **SQ-04-F**)

## Ordering Information

Flexi-Shield is sold by the foot and typically packaged on spools except in small quantities. It can also be ordered cut-to-length in specific sizes or you can cut it yourself using a sharp pair of scissors. Not all configurations are stock items. Contact us for availability. Custom o-rings also available as described on page 37.



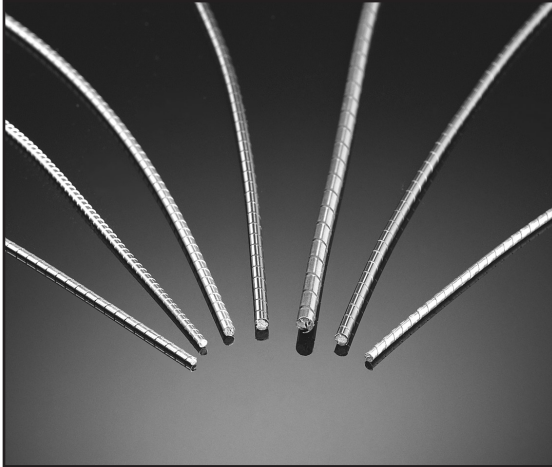

This gasket uses our high shielding tin plated beryllium copper Spira-Shield as its base. We inject a liquid silicone adhesive into the center of the spiral, which hardens and bonds completely to the metal, making this gasket extremely durable when properly used.

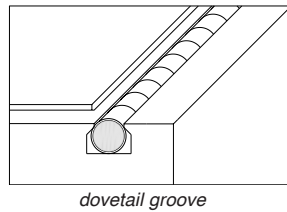

See page 51 for groove mounting techniques.

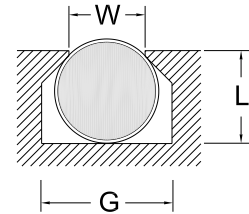

Outer Conductive Spiral:  
Tin/Lead Plated Beryllium Copper



Resilient Inner Core:  
Solid Silicone

Enduro-Shield Part Numbers (Tin/Lead Plated Beryllium Copper)				Recommended Groove Dimensions		
Diameter	Standard Force	Moderate Force	Low Force	Depth (L) +.002"-.000"	Width (G) +.007"-.005"	Width (W) +.000"-.002"
.034" ± .002"	SISS-02	SIMS-02	--	.023"	.046"	.033"
.047" ± .002"	SISS-03	SIMS-03	--	.035"	.063"	.045"
.063" ± .003"	SISS-04	SIMS-04	SILS-04	.046"	.094"	.060"
.070" ± .003"	SISS-.070	SIMS-.070	SILS-.070	.053"	.094"	.067"
.078" ± .003"	SISS-05	SIMS-05	SILS-05	.059"	.109"	.075"
.094" ± .004"	SISS-06	SIMS-06	SILS-06	.070"	.125"	.090"
.103" ± .004"	SISS-.103	SIMS-.103	SILS-.103	.077"	.141"	.099"
.109" ± .004"	SISS-07	SIMS-07	SILS-07	.082"	.156"	.105"
.125" ± .004"	SISS-08	SIMS-08	SILS-08	.094"	.171"	.121"
.139" ± .005"	SISS-.139	SIMS-.139	SILS-.139	.104"	.187"	.134"
.141" ± .005"	SISS-09	SIMS-09	SILS-09	.105"	.187"	.134"

See page 51 for groove mounting techniques.  
Dovetail Groove Cutters detailed on page 36.

## Application Information

Because of its durability, Enduro-Shield is ideal for groove-mounted sliding applications, such as in connectors. This gasket material is used in our Enduro-Shield O-rings. (See page 11.)

### Materials

See page 59 for material specifications.

**Spiral:** Tin/lead plated beryllium copper. (See *Options* for RoHS compliance).  
Electroplated, 90% tin, 10% lead (edges unplated).

**Inner Core:** Cured silicone adhesive.

### Shielding Quality

This gasket offers shielding quality from 117 dB to 152 dB. The shielding quality may vary depending on your specific application. Refer to page 50 for more complete performance data.



## Compression Force

Enduro-Shield gaskets come in three different resiliencies (as shown below). Optimal compression of the gasket is 25% of the diameter of the spiral. Since the force to compress the gasket is a function of the cube of the thickness of the beryllium copper ribbon, the compression forces shown are approximate. Some sizes are also available in low force. Please contact us for information.

**Standard Force:** ~30 pounds per linear inch compression.

**Moderate Force:** ~10 pounds per linear inch compression.

**Low Force:** ~1.5 pounds per linear inch compression.

## Mounting

This gasket is groove mounted.

## Available Options

### Custom Sizes

We can manufacture Enduro-Shield gaskets in any size diameter, from .034" up to .141". There may be a nominal tooling charge for special sizes. Please contact us with your requirements.

### Plating

See page 60 for material compatibility information.

Plating options can be specified by adding a prefix before the part number:

**E:** Edge tin/lead plating (includes edges) for high humidity or salt-fog environments

**IW:** RoHS compliant tin plating (Example: **IWSIMS-08**)

**EIW:** RoHS compliant edge tin plating for high humidity or salt-fog

### Material

Stainless steel material may also be substituted if desired. Please see the following chart for part number options.

Specify material by choosing the desired prefix from the table.

Example:  
**SITNI-09**  
Tin Plated St. Steel  
Standard Force

Material	Force	No Plating	Tin/lead Plating	RoHS Tin	Edge Tin/Lead	RoHS Edge Tin
<b>Beryllium Copper</b>	Standard Moderate Low	--	SISS (default) SIMS SILS	IWSISS IWSIMS IWSILS	ESISS ESIMS ESILS	EIWSISS EIWSIMS EIWSILS
<b>Stainless Steel</b>	Standard Moderate Low	SINI SINM SINL	SITNI SITNM SITNL	IWSINI IWSINM IWSINL	--	--

### Special Core

A special core can be specified by using the following option:

**-F:** Fluorosilicone (Example: **SIMS-08-F**)

**-O:** Silicone that meets outgassing requirements

**-Z:** Silicone which is a non-acetic acid adhesive (per MIL-A-46146)

**Note:** EMI/Environmental version in development. Contact us for more information.

## Ordering Information

Enduro-Shield is sold by the piece in four foot lengths. It can be spliced together to make longer lengths upon request. Enduro-Shield can also be ordered cut-to-length in specific sizes or you can cut it yourself using a sharp pair of scissors. Not all configurations are stock items. Contact us for availability. To order o-rings please refer to the Enduro-Shield O-Ring section, or the Custom Gaskets section, page 37.

# O-Rings: Enduro-Shield & Flexi-Shield

Flexi-Shield and Enduro-Shield O-Rings are designed to provide an EMI seal for the life of a system. These o-rings are ideal for use in jam-nut connectors. In actual use, this gasket has achieved up to 1,000 insertions.

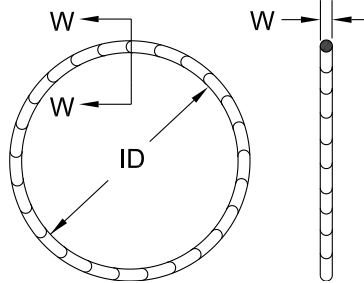
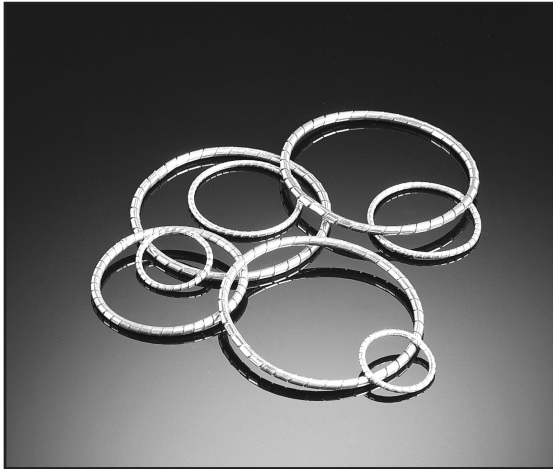

Part Number:  
 Flexi-Shield: FSOG-B-\_\_\_\_\_  
 Enduro-Shield: SSOG-B-\_\_\_\_\_  
 Dash No. From Table

Dash No.	Dimensions			
	W Dia.	Tol.	ID	Tol.
011	.070"	±.003	.301"	±.020"
012			.364"	
013			.426"	
014			.489"	
015			.551"	
016			.614"	
017			.676"	
018			.739"	
019			.801"	
020			.864"	
021			.926"	
022			.989"	
023			1.051"	
024			1.114"	
025			1.176"	
026			1.239"	
027			1.301"	
028			1.364"	
029			1.489"	
030			1.614"	
031			1.739"	
032			1.864"	
033			1.989"	
034	.070"	±.003"	2.114"	±.030"
035			2.239"	
036			2.364"	
037			2.489"	
038			2.614"	
039			2.739"	
040			2.864"	
041			2.989"	
042			3.239"	
043			3.489"	
044			3.739"	
045			3.989"	
046			4.239"	
047			4.489"	
048			4.739"	
049			4.989"	
050			5.239"	
111	.103"	±.004"	.424"	±.020"
112			.487"	
113			.549"	
114			.612"	
115			.674"	
116			.737"	
117			.799"	
118			.862"	
119			.924"	
120			.987"	
121			1.049"	
122			1.112"	
123			1.174"	
124			1.237"	
125			1.299"	
126			1.372"	
127			1.424"	
128			1.487"	
129			1.549"	

Dash No.	Dimensions			
	W Dia.	Tol.	ID	Tol.
130	.103"	±.004"	1.612"	±.020"
131			1.674"	
132			1.737"	
133			1.799"	
134			1.862"	
135			1.925"	
136			1.987"	
137	.103"	±.004"	2.050"	±.030"
138			2.112"	
139			2.175"	
140			2.237"	
141			2.300"	
142			2.362"	
143			2.425"	
144			2.487"	
145			2.550"	
146			2.612"	
147			2.675"	
148			2.737"	
149			2.800"	
150			2.862"	
151			2.987"	
152			3.237"	
153			3.487"	
154			3.737"	
155	.103"	±.004"	3.987"	±.035"
156			4.237"	
157			4.487"	
158			4.737"	
159			4.987"	
160			5.237"	
161			5.487"	
162			5.737"	
163			5.987"	
164			6.237"	
165			6.487"	
166			6.737"	
167			6.987"	
168			7.237"	
169			7.487"	
170			7.737"	
171			7.987"	
172			8.237"	
173			8.487"	
174	.103"	±.004"	8.737"	±.040"
175			8.987"	
176			9.237"	
177			9.487"	
178			9.737"	
210	.139"	±.005"	.734"	±.020"
211			.796"	
212			.859"	
213			.921"	
214			.984"	
215			1.046"	
216			1.109"	
217			1.171"	
218			1.234"	
219			1.296"	

Dash No.	Dimensions			
	W Dia.	Tol.	ID	Tol.
220	.139"	±.005"	1.359"	±.020"
221			1.421"	
222			1.484"	
223			1.609"	
224			1.734"	
225			1.859"	
226			1.984"	
227			2.109"	
228			2.234"	
229			2.359"	
230			2.484"	
231			2.609"	
232			2.734"	
233			2.859"	
234			2.984"	
235	.139"	±.005"	3.109"	±.030"
236			3.234"	
237			3.359"	
238			3.484"	
239			3.609"	
240			3.734"	
241			3.859"	
242			3.984"	
243			4.109"	
244			4.234"	
245			4.359"	
246			4.484"	
247			4.609"	
248			4.734"	
249			4.859"	
250			4.984"	
251	.139"	±.005"	5.109"	±.035"
252			5.234"	
253			5.359"	
254			5.484"	
255			5.609"	
256			5.734"	
257			5.859"	
258	.139"	±.005"	5.984"	±.040"
259			6.234"	
260			6.484"	
261			6.734"	
262			6.984"	
263			7.234"	
264			7.484"	
265			7.734"	
266			7.984"	
267			8.234"	
268			8.484"	
269			8.734"	
270			8.984"	
271	.139"	±.005"	9.234"	±.045"
272			9.484"	
273			9.734"	
274			9.984"	
275			10.484"	
276			10.984"	
277	.139"	±.005"	11.484"	±.050"
278			11.984"	
279			12.984"	
280			13.984"	
281			14.984"	
282			15.955"	
283			16.955"	
284			17.955"	

## Application Information

These gaskets are a one-on-one replacement for military "AS" series o-rings. The dash numbers of the gaskets in the table are dimensionally interchangeable with AS568 o-ring dash numbers. Custom size o-rings are also available. Please refer to Custom Gaskets for more information.

### Materials

See page 59 for material specifications.

These o-rings are made out of our standard force Enduro-Shield or Flexi-Shield gasket material. The solid core or tubing makes it extremely durable, especially in sliding applications like connectors.

**Spiral:** Tin/lead plated beryllium copper. (See *Options* for RoHS compliance).

**Core:** *Flexi-Shield:* 60 durometer silicone tubing. *Enduro-Shield:* cured silicone adhesive.

### Shielding Quality

Enduro-Shield or Flexi-Shield O-Rings offer shielding quality from 116 dB to 152 dB. The shielding quality of each type may vary depending on your specific application. Refer to Shielding Quality for more complete performance data.

### Compression Force

Enduro-Shield or Flexi-Shield standard O-Rings require approximately 30 pounds per linear inch to compress properly. Optimal compression of the gasket is 25% of the diameter of the spiral.

## Available Options

### Plating

See page 60 for material compatibility information.

Specify a different spiral material by choosing the desired prefix from the table.

Example:  
**IWFSSOG-B-220**  
RoHS tin plated  
Flexi-Shield O-Ring

The gasket is electroplated, 90% tin, 10% lead (edges unplated).

Plating options can be specified by adding a prefix before the part number:

**E:** Edge tin/lead plating (includes edges) for high humidity or salt-fog environments

**IW:** RoHS compliant tin plating (Example: **IWFSSOG-B-050**)

**EIW:** RoHS compliant edge tin plating for high humidity or salt-fog

O-Ring	Force	Tin/lead Plating	RoHS Tin	Edge Tin/Lead	RoHS Edge Tin
<b>Enduro-Shield</b>	Standard	SSOG (default)	IWFSSOG	ESSOG	EIWFSSOG
<b>Flexi-Shield</b>	Standard	FSSOG	IWFSSOG	EFSSOG	EIWFSSOG

### Core Material

The core for Flexi-Shield O-Rings (**FSSOG**) is commercial grade silicone tubing. Fluorosilicone is also available by request.

The standard core for Enduro-Shield O-Rings (**SSOG**) is silicone.

A special core can be requested for SSOG O-Rings (as shown below):

**-F:** Fluorosilicone (Example: **ESSOG-B-050-F**)

**-O:** Space Qualified Silicone: non-outgassing (Enduro-Shield only)

**-Z:** Silicone which is a non-acetic acid adhesive (per MIL-A-46146)

**Note:** An EMI/Environmental O-Ring is in development. Contact us for details.

## Ordering Information

O-Rings are ordered by the piece. Custom sizes are also available. See page 37. Not all configurations are stock items. Contact us for availability.

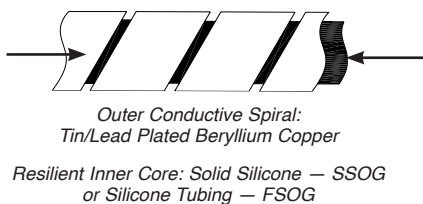

Recommended Groove Dimensions		
W Diameter	Depth	Width
.070"	.053"	.094"
.103"	.077"	.141"
.139"	.104"	.187"

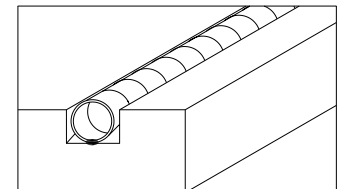

See page 51 for groove mounting techniques.

# “D” Multi-Seal



“D” Multi-Seal is a groove-mounted gasket with a bulbous silicone elastomer for an excellent environmental seal. It comes standard with the Spira-Shield for superior shielding quality or can be ordered with any other spiral material.

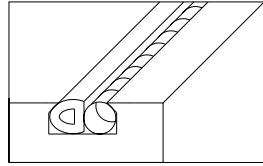

See page 51 for groove mounting techniques.

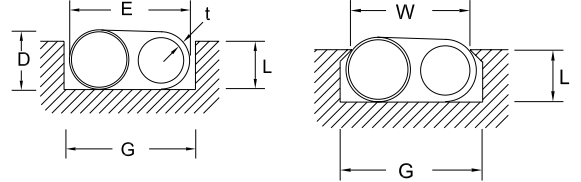

You can use either a dovetail or conventional o-ring groove.

Gasket Dimensions			“D” Multi-Seal Part Numbers (Spira-Shield Gasket)			Recommended Mounting Dimensions		
Width of Gasket (E)	Spiral Diameter (D)	Thickness of Wall (t)	Standard Force*	Moderate Force	Low Force	Depth (L) +.002”- .000”	Width (G) +.007”- .005”	Width (W) +.000”- .002”
.141”	.063” ± .003”	N/A**	DSS-0421	DMS-0421 NC	--	.046”	.187”	.138”
.187”	.094” ± .004”	N/A**	DSS-0632	DMS-0632 NC	--	.070”	.250”	.180”
.250”	.125” ± .004”	.031”	DSS-0842	DMS-0842 NC	--	.094”	.313”	.240”
.375”	.187” ± .006”	.047”	DSS-1263	DMS-1263 NC	--	.140”	.500”	.367”
.500”	.250” ± .007”	.047”	DSS-1684	DMS-1684 NC	--	.188”	.625”	.485”

Moderate force gaskets come without a cord unless specified otherwise. (See Options).

\* All standard force gaskets come without a cord.

\*\* These sizes come with a solid elastomer.

See page 51 for groove mounting techniques.

Dovetail Groove Cutters detailed on page 36.

## Application Information

This combination EMI and environmental gasket is ideal for applications that need excellent sealing and have somewhat limited space or want to utilize a groove-mount solution. (For surface mount applications, see the Basic Multi-Seal data sheet, page 15).

### Materials

See page 59 for material specifications.

**Spiral:** Spira-Shield, Tin/lead plated beryllium copper.

**Elastomer option:** Solid silicone rubber, 40 durometer on -0421, -0632; 60 durometer all other sizes. (See Options for RoHS compliance or other material choices).

### Shielding Quality

This gasket offers shielding quality from 86 dB to 165 dB. The shielding quality may vary depending on your specific application. Refer to page 48 for more complete performance data.

### Compression Force

“D” Multi-Seal gaskets comes in two different resiliencies (as shown below). Optimal compression of the gasket is 25% of the diameter of the spiral. Since the force to compress the gasket is a function of the cube of the thickness of the beryllium copper ribbon, the compression forces shown are approximate.

**Standard Force:** ~33 pounds per linear inch compression.

**Moderate Force:** ~13 pounds per linear inch compression.

## Mounting

This gasket is groove mounted. Refer to Groove Mounting Techniques on page 51 for detailed mounting information.

## Available Options

### Spiral Material

See page 60 for material compatibility information.

“D” Multi-Seal comes standard with a tin/lead plated Spira-Shield gasket. Other spiral materials or plating may be specified by choosing a different prefix from the following table. See pages 1-10 for more information on the Spiral materials.

1. Choose the desired gasket from the table on page 13 based on size and force.  
Example: **DMS-1263**, moderate force, E=.375”, D=.187”
2. Substitute the prefix from the table below based on spiral material and plating.  
Example: **DEMT-1263**, moderate force Flexi-Shield, edge tin/lead plated BC.

Specify a different spiral material by choosing the desired prefix from the table.

Example:  
**DEIWSS-1263**  
“D” Multi-Seal  
RoHS edge plated  
Spira-Shield gasket  
Standard force  
(No cord by default)

	Spira-Shield	Quick & Ultra Quick-Shield	Flexi-Shield	
Spiral:	Tin Plated BC	St. Steel	Tin Plated BC	St. Steel
Standard: Tin/Lead or No Plating	DSS (default) DMS	DNI DNM	DST DMT	DSQ DMQ
Tin/Lead or Edge Plating Option (T or E)	DESS DEMS	DTNI DTNM	DEST DEMT	DTSQ DTMQ
RoHS Tin Plating Option (IW)	DIWSS DIWMS	DIWNI DIWNM	DIWST DIWMT	DIWSQ DIWMQ
RoHS Edge Tin Plating Option (EIW)	DEIWSS DEIWMS	--	DEIWST DEIWMT	--

### Cord Insert

Standard Force gaskets come without a cord and we recommend to omit the cord in all gaskets by specifying “NC” (no cord). Cord is available if needed in PVC, solid fluorosilicone, solid silicone and thermal plastic rubber depending on the size and should be ordered to match the elastomer chosen. Please contact us for details.  
**NC:** No Cord (Example: DMS-1263 NC)

### Special Elastomer

The standard elastomer is solid silicone. A special elastomer can be specified as shown below (available in certain sizes only). Note that these elastomers (as with most special options) are non-stock items and will include additional charges.

/E: EPDM\* (Example: **DMS-1263 /E**)

/F: Fluorosilicone\*

/O: Space Qualified Silicone\* (non-outgassing)

\* **Note:** Cord will match elastomer choice if included.

## Ordering Information

“D” Multi-Seal is sold by the foot in 10 foot lengths. Custom o-rings are also available. (See page 37). Not all configurations are stock items. Contact us for availability.



# Basic Multi-Seal

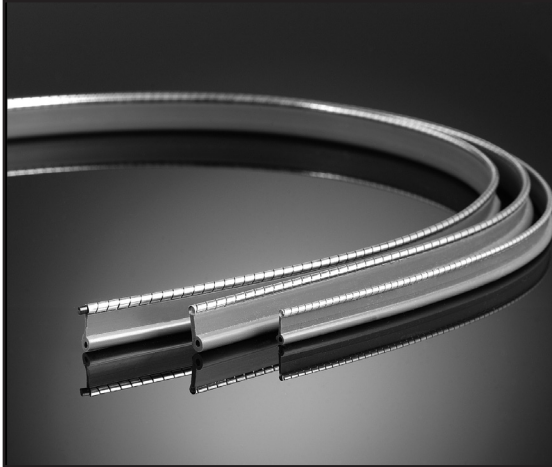

Spira's Basic Multi-Seal gasket is the gasket of choice when you need an outstanding environmental seal for a surface mount application. The standard configuration (shown below) includes a Spira-Shield gasket for superior shielding, or see *Options* for other spiral materials.

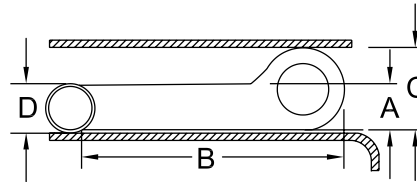

See page 55 for surface mounting information.

Gasket Dimensions					Basic Multi-Seal Part Numbers (Spira-Shield Gasket)		
Elastomer Thickness A	Elastomer Width B	Bulb Thickness C	Spiral Diameter D	Total Gasket Width	Standard Force*	Moderate Force	Low Force
.063"	.375"	.125"	.094"	.469"	CSS-0623	CMS-0623	CLS-0623
.094"	.375"	.187"	.125"	.500"	CSS-0833	CMS-0833	CLS-0833
.094"	.500"	.187"	.125"	.625"	CSS-0834	CMS-0834	CLS-0834
.094"	.625"	.187"	.125"	.750"	CSS-0835	CMS-0835	CLS-0835

Moderate and low force gaskets come with a cord unless specified otherwise. (See *Options*).

\*All standard force gaskets come without a cord.

## Application Information

The Multi-Seal gasket is made by attaching the Spira-Shield gasket to a silicone elastomeric extrusion. The extrusion is used to hold the EMI gasket in place and provides an excellent, low force environmental seal. This gasket can be made into a custom Framed Gasket to your specifications. (See page 38).

### Materials

See page 59 for material specifications.

**Spiral:** Spira-Shield, Tin/lead plated beryllium copper.

**Elastomer:** Solid silicone rubber, 60 durometer.

(See *Options* for RoHS compliance or other material choices).

### Shielding Quality

This gasket offers shielding quality from 86 dB to 165 dB. The shielding quality may vary depending on your specific application. Refer to Shielding Quality for more complete performance data.

### Compression Force

Basic Multi-Seal gaskets come in three different resiliencies (as shown below). Optimal compression of the gasket is 25% of the diameter of the spiral. Since the force to compress the gasket is a function of the cube of the thickness of the beryllium copper ribbon, the compression forces shown are approximate.

**Standard Force:** ~33 pounds per linear inch compression.

**Moderate Force:** ~13 pounds per linear inch compression.

**Low Force:** ~5 pounds per linear inch compression.

## Mounting

This gasket is surface mounted. See page 55 for detailed mounting information.

For groove mount applications where you need environmental sealing, refer to our "D" Multi-Seal data sheet on page 13.

## Available Options

### Spiral Material

See page 60 for material compatibility information.

Basic Multi-Seal comes standard with a tin/lead plated Spira-Shield gasket. Other spiral materials or plating may be specified by choosing a different prefix from the following table. See pages 1-10 for more information on the Spiral materials.

1. Choose the desired gasket from the table on page 15 based on size and force.  
Example: **CMS-0835**, moderate force
2. Substitute the prefix from the table below based on spiral material and plating.  
Example: **CESIMS-0835**, moderate force Enduro-Shield, edge tin/lead plated BC.

Specify a different spiral material by choosing the desired prefix from the table.

Example:  
**CIWST-0833**  
Basic Multi-Seal  
Flexi-Shield RoHS  
Tin plated beryllium  
copper gasket  
Standard force  
(Includes cord)

	Spira-Shield	Quick & Ultra Quick-Shield	Flexi-Shield	
Spiral:	Tin Plated BC	St. Steel	Tin Plated BC	St. Steel
<b>Standard: Tin/Lead or No Plating</b>	CSS (default) CMS CLS	CNI CNM CNL	CST CMT CLT	CSQ CMQ CLQ
<b>Tin/Lead or Edge Plating Option (T or E)</b>	CESS CEMS CELS	CTNI CTNM CTNL	CEST CEMT CELT	CTSQ CTMQ CTLQ
<b>RoHS Tin Plating Option (IW)</b>	CIWSS CIWMS CIWLS	CIWNI CIWNM CIWNL	CIWST CIWMT CIWLT	CIWSQ CIWMQ CIWLQ
<b>RoHS Edge Tin Plating Option (EIW)</b>	CEIWSS CEIWMS CEIWLS	--	CEIWST CEIWMT CEIWLT	--

### Cord Insert

Standard Force gaskets come without a cord and we recommend to omit the cord in all gaskets by specifying "NC" (no cord). Cord is available if needed in PVC, solid fluorosilicone, solid silicone and thermal plastic rubber depending on the size and should be ordered to match the elastomer chosen. Please contact us for details.  
**NC:** No Cord (Example: **CMS-0835 NC**)

### Special Elastomer

The standard elastomer is solid silicone. A special elastomer can be specified as shown below (available in certain sizes only). Note that these elastomers (as with most special options) are non-stock items and will include additional charges.

**/E:** EPDM\* (Example: **CMS-0835 /E**)

**/F:** Fluorosilicone\*

**/O:** Space Qualified Silicone\* (non-outgassing)

\* **Note:** Cord will match elastomer choice if included.

## Ordering Information

Basic Multi-Seal is sold by the foot in approximately 25 foot lengths and typically packaged on cardboard flats except in small quantities. Not all configurations are stock items. Contact us for availability.

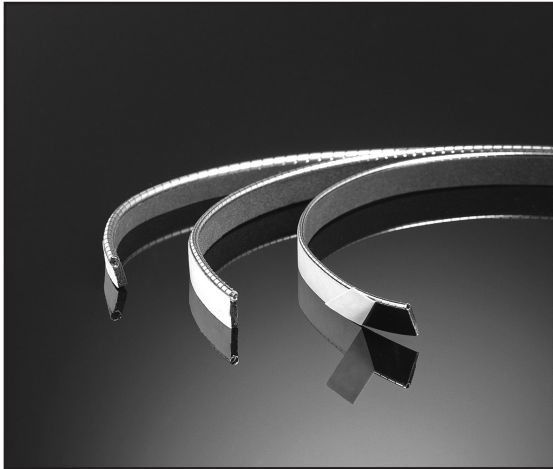

Spira's Quick-Strip gasket includes a "peel-n-stick" adhesive backing on a neoprene sponge elastomer. It's an easy-to-use, low cost solution providing low to high shielding quality as needed. The standard configuration (shown below) includes a Quick-Shield gasket or see *Options* for other materials.

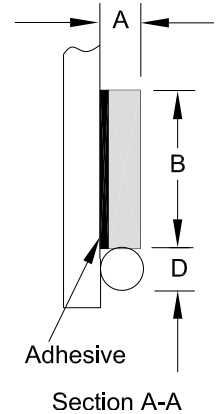

See page 55 for surface mounting information.

Gasket Dimensions			Quick-Strip Part Numbers (Quick-Shield Gasket)		
Elastomer Thickness (A)	Elastomer Width (B)	Spiral Diameter (D)	Standard Force*	Moderate Force	Low Force
.063"	.250"	.063"	NI-0422-A /P	NM-0422-A NC /P	NL-0422-A NC /P
	.375"		NI-0423-A /P	NM-0423-A NC /P	NL-0423-A NC /P
.094"	.250"	.094"	NI-0632-A /P	NM-0632-A NC /P	NL-0632-A NC /P
	.375"		NI-0633-A /P	NM-0633-A NC /P	NL-0633-A NC /P
.125"	.250"	.125"	NI-0842-A /P	NM-0842-A NC /P	NL-0842-A NC /P
	.375"		NI-0843-A /P	NM-0843-A NC /P	NL-0843-A NC /P
.187"	.250"	.187"	NI-1262-A /P	NM-1262-A NC /P	NL-1262-A NC /P

\*All standard force gaskets come without a cord.

Custom sizes also available. Contact us for details.

## Application Information

Quick-Strip can either be used in a continuous length along the perimeter of a chassis, or cut into small pieces and used at strategic intervals. When meeting relatively low shielding requirements such as FCC and European Community, you can often meet those requirements by using a few small pieces of gasket. This allows you to get the shielding you need, while minimizing both the gasket and labor costs. The best way to figure out how many segments you need is during the testing phase of the design. Place a few 1" pieces of gasket around the perimeter of your box. Run a baseline test and then add and subtract gasket pieces until you find the optimal number. This also allows you to upgrade by adding a few more pieces if you later need to meet more stringent requirements or the frequency of your internal electronics goes up in subsequent product modifications.

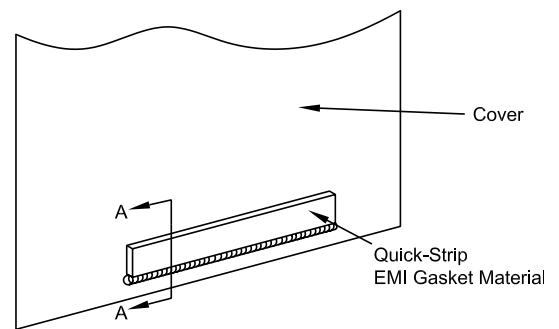

## Materials

**Spiral:** Quick-Shield, Stainless steel. (See *Options* for other spiral materials).  
**Elastomer:** Neoprene sponge with adhesive backing.

## Shielding Quality

This gasket offers shielding quality greater than 95 dB in continuous lengths. Small pieces of Quick-Strip will offer less shielding; how much less will depend on the size of the gap between pieces and your particular design. Refer to page 49 for more complete performance data.

## Compression Force

Quick-Strip gaskets come in three different resiliencies (as shown below). Optimal compression of the gasket is 25% of the diameter of the spiral. The compression forces shown are approximate.

**Standard Force:** ~30 pounds per linear inch compression.

**Moderate Force:** ~10 pounds per linear inch compression.

**Low Force:** ~1.5 pounds per linear inch compression.

## Mounting

This gasket is surface mounted. See page 55 for detailed mounting information.

## Available Options

### Spiral Material

Specify a different spiral material by choosing the desired prefix from the table.

Example:  
**IWNM-0632-A NC /P**  
Quick Strip, RoHS  
Quick-Shield gasket  
Moderate force  
No cord

See page 60 for material compatibility information.

	Spira-Shield	Quick & Ultra Quick-Shield	Enduro-Shield		Flexi-Shield	
Spiral:	Tin Plated BC	St. Steel	Tin Plated BC	St. Steel	Tin Plated BC	St. Steel
<b>Standard: Tin/Lead or No Plating</b>	SS MS LS	NI (default) NM NL	SISS SIMS SILS	SINI SINM SINL	ST MT LT	SQ MQ LQ
<b>Tin/Lead or Edge Plating Option (T or E)</b>	ESS EMS ELS	TNI TNM TNL	ESISS ESIMS ESILS	SITNI SITNM SITNL	EST EMT ELT	TSQ TMQ TLQ
<b>RoHS Tin Plating Option (IW)</b>	IWSS IWMS IWLS	IWNI IWNM IWNL	IWSISS IWSIMS IWSILS	IWSINI IWSINM IWSINL	IWST IWMT IWLT	IWSQ IWMQ IWLQ
<b>RoHS Edge Tin Plating Option (EIW)</b>	EIWSS EIWMS EIWLS	--	EIWSISS EIWSIMS EIWSILS	--	EIWST EIWMT EIWLT	--

## Cord Insert

To keep costs low, we recommend you omit the cord usually used in the spiral. However, if over-compression of the gasket is a concern or problem, remove the "NC" from the part number on the moderate and low force series gaskets.

Example: **NM-0632-A /P** will include cord.

All Standard Force gaskets come without cord (no NC required).

## Special Elastomer

We recommend the use of neoprene sponge elastomer because it is the lowest cost of popular elastomers. Silicone sponge elastomer can also be specified as shown below. (For solid elastomers, please see the Spira-Strip gasket on page 19).

**/C:** Silicone sponge (Example: **NM-0632-A /C**)

## Adhesive Backing

Neoprene sponge elastomers only come with pressure sensitive adhesive (PSA) backing. Silicone sponge elastomers can be ordered without adhesive backing by dropping the -A designation in the part number.

Example: **NM-0632 NC /P**

## Ordering Information

Quick-Strip is sold by the foot and typically packaged in coils except in small quantities. It can also be ordered cut-to-length in specific sizes at a very low cost, or you can cut it yourself using a sharp pair of scissors. Not all configurations are stock items. Contact us for availability.

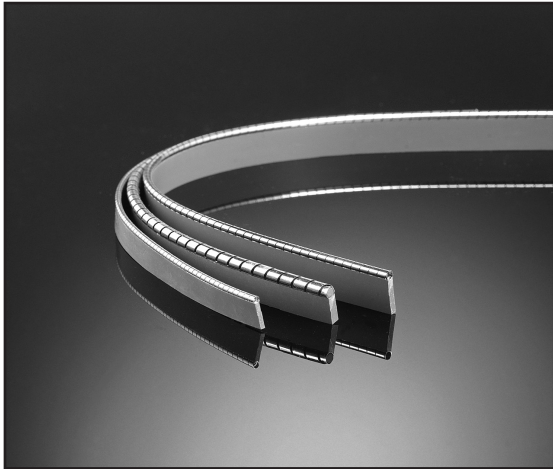

Our Spira-Strip gasket includes a solid silicone elastomer to surface mount the gasket and provide an environmental seal if needed. The standard configuration (shown below) includes a Spira-Shield gasket. See *Options* to specify a different spiral material as desired.

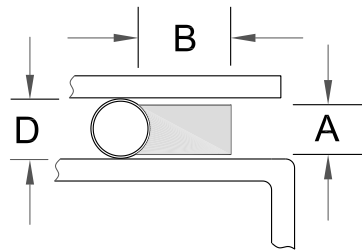

*Spiral on solid silicone elastomer.*

*See page 55 for surface mounting information.*

Gasket Dimensions				Spira-Strip Part Numbers (Spira-Shield Gasket)		
Elastomer Thickness (A)	Elastomer Width (B)	Spiral Diameter (D)	Total Gasket Width	Standard Force*	Moderate Force	Low Force
.063"	.250"	.078"	.328"	SS-0522 /S	MS-0522 /S	LS-0522 /S
	.375"		.453"	SS-0523 /S	MS-0523 /S	LS-0523 /S
	.500"		.578"	SS-0524 /S	MS-0524 /S	LS-0524 /S
	.625"		.703"	SS-0525 /S	MS-0525 /S	LS-0525 /S
.094"	.250"	.109"	.359"	SS-0732 /S	MS-0732 /S	LS-0732 /S
	.375"		.484"	SS-0733 /S	MS-0733 /S	LS-0733 /S
	.500"		.609"	SS-0734 /S	MS-0734 /S	LS-0734 /S
	.625"		.734"	SS-0735 /S	MS-0735 /S	LS-0735 /S
.125"	.250"	.156"	.406"	SS-1042 /S	MS-1042 /S	LS-1042 /S
	.375"		.531"	SS-1043 /S	MS-1043 /S	LS-1043 /S
	.500"		.656"	SS-1044 /S	MS-1044 /S	LS-1044 /S
	.625"		.781"	SS-1045 /S	MS-1045 /S	LS-1045 /S

Moderate and low force gaskets come with a cord unless specified otherwise. (See *Options*).

\*All standard force gaskets come without a cord.

## Application Information

This gasket is made by attaching our Spira-Shield to a solid silicone elastomer which holds the spiral in place. The elastomer can be used to achieve an environmental seal of up to one atmosphere! This gasket can also be made into a custom Framed Gasket to your specifications. (See page 38).

### Materials

See page 59 for material specifications.

**Spiral:** Spira-Shield, Tin/lead plated beryllium copper. (See *Options* for others).

**Cord:** 80 durometer PVC (hard plastic).

**Elastomer:** 40 durometer solid silicone rubber.

### Shielding Quality

This gasket offers shielding quality from 86 dB to 165 dB. The shielding quality may vary depending on your specific application. Refer to page 48 for more complete performance data.



## Compression Force

Spira-Strip gaskets come in three different resiliencies (as shown below). Optimal compression of the gasket is 25% of the diameter of the spiral. The compression forces shown are approximate.

**Standard Force:** ~30 pounds per linear inch compression.

**Moderate Force:** ~10 pounds per linear inch compression.

**Low Force:** ~1.5 pounds per linear inch compression.

**Note:** The force to achieve an environmental seal is significantly greater than that required for the EMI seal.

## Mounting

See page 55 for surface mounting information.

This gasket is surface mounted and held in place either by punching holes in the elastomer and securing it with fasteners or by gluing the elastomer using an RTV adhesive. When using glue, take care to keep it off the spiral!

## Available Options

### Spiral Material

Specify a different spiral material by choosing the desired prefix from the table.

Example:  
**TNL-0523 NC /S**  
Spira-Strip with Ultra Quick-Shield Gasket  
Low Force, No Cord

See page 60 for material compatibility information.

	Spira-Shield	Quick & Ultra Quick-Shield	Flexi-Shield	
Spiral:	Tin Plated BC	St. Steel	Tin Plated BC	St. Steel
<b>Standard: Tin/Lead or No Plating</b>	SS (default) MS LS	NI NM NL	ST MT LT	SQ MQ LQ
<b>Tin/Lead or Edge Plating Option (T or E)</b>	ESS EMS ELS	TNI TNM TNL	EST EMT ELT	TSQ TMQ TLQ
<b>RoHS Tin Plating Option (IW)</b>	IWSS IWMS IWLS	IWNI IWNM IWNL	IWST IWMT IWLTL	IWSQ IWMQ IWLQ
<b>RoHS Edge Tin Plating Option (EIW)</b>	EIWSS EIWMS EIWLS	--	EIWST EIWMT EIWLT	--

### Cord Insert

Standard Force gaskets come without a cord and we recommend to omit the cord in all gaskets by specifying "NC" (no cord). Cord is available if needed in PVC, solid fluorosilicone, solid silicone and thermal plastic rubber depending on the size and should be ordered to match the elastomer chosen. Please contact us for details.  
**NC:** No Cord (Example: **MS-1043 NC /S**)

### Special Elastomer

Spira-Strip gaskets come with a solid silicone elastomer. A solid fluorosilicone elastomer is available on special request.\* (For sponge elastomers, please see the Quick-Strip gasket on page 17). Cord will match elastomer choice if included.

### Adhesive Backing

Some sizes can be configured with an adhesive tape backing for easy attachment. Please contact us for details.

## Ordering Information

Spira-Strip is sold by the foot and typically packaged on cardboard flats except in small quantities. It can also be ordered cut-to-length in specific sizes or you can cut it yourself using a sharp pair of scissors. Not all configurations are stock items. Contact us for availability.

# Spira's Connector-Seal Gaskets

Spira offers the best Connector-Seal gaskets on the market, providing an excellent, durable and reusable EMI and/or Environmental seal in flange-mounted connectors for the life of a system. The durability and longevity of the gasket is due to the unique frame design with vulcanized elastomer/rubber sealing on both sides of a metal plate. The metal plate provides strength and eliminates cold flow of the environmental sealing elastomer. This page gives an overview of Spira's Connector-Seal gaskets. Please see the following pages for the product datasheets and ordering specifications.

## Environmental-Only Connector-Seal

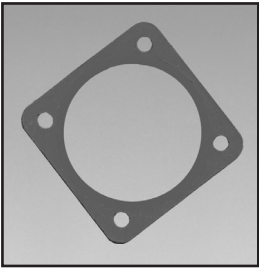

Provides an excellent and durable environmental seal for the life of a system.

The **EOCS** frame is silicone or fluorosilicone rubber elastomer material sealed over salt-fog & corrosion resistant stainless steel with **no EMI gasket**. The dimensions are the same as the EMI-Only Connector-Seal (CS and SSCG series) below.

**Environmental-Only** Connector-Seal Part Number Prefix: **EOCS**  
Can be used for Back-Mount or Front-Mount applications.

## EMI & Environmental Connector-Seal

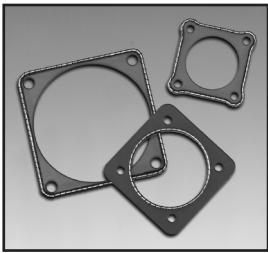

Provides superior EMI shielding and an excellent and durable environmental seal.

The **ECS** and **FMECS** frame is silicone or fluorosilicone rubber elastomer material sealed over corrosion resistant metal, with a Spira-Shield (or other) EMI gasket.

Order in Back-Mount or Front-Mount configuration as needed:

**Back-Mount** Connector-Seal Part Number Prefix: **ECS** *(EMI gasket is on the inside.)*

**Front-Mount** Connector-Seal Part Number Prefix: **FMECS** *(EMI gasket is on the outside.)*

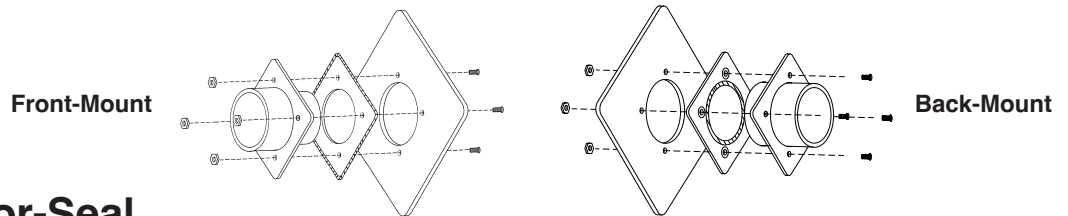

## EMI-Only Connector-Seal

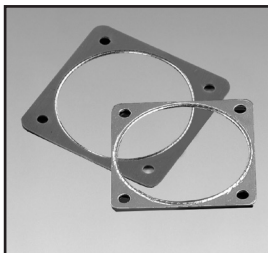

Provides excellent EMI Shielding and durability for the life of a system.

The **CS** Connector-Seal is a more durable and cost effective replacement of Spira's original Connector-Seal gasket (SSCG series) and provides **EMI-Only** shielding. The frame is silicone or fluorosilicone rubber elastomer material sealed over corrosion resistant metal, with a Spira-Shield (or other) EMI gasket. The CS gasket looks similar to the EMI & Environmental Connector-Seal (ECS) above, but due to frame dimensions it **does not provide Environmental sealing**.

**EMI-Only** Connector-Seal Part Number Prefix: **CS** *(Same dimensions as old SSCG gaskets.)*  
Can be used for Back-Mount or Front-Mount applications.

# Environmental-Only Connector-Seal

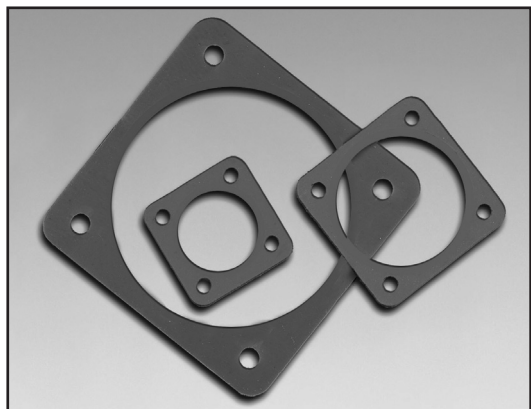

Spira's **Environmental-Only** Connector-Seal gaskets provide an excellent and durable environmental seal in flange-mounted connectors for the life of a system.

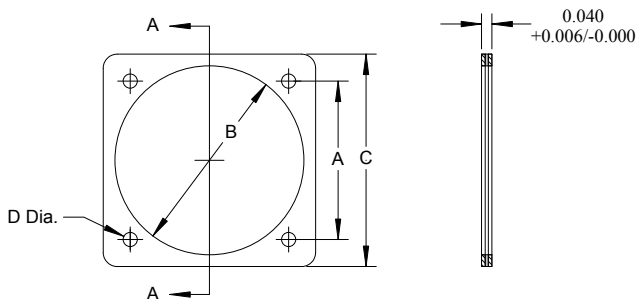

## Materials

The frame is salt-fog and corrosion resistant stainless steel sealed on both sides by silicone or fluorosilicone rubber elastomer. **No EMI gasket.** See the following pages for EMI & Environmental Sealing.

## Ordering Information

**Environmental-Only** Connector-Seal gaskets are ordered by the piece. Not all configurations are stock items. Contact us for availability.

Part Number:

EOCS - \_\_\_ / \_\_\_

Dash No.  
From Table

Frame Material:

/S: Silicone over Stainless Steel  
/F: Fluorosilicone over Stainless Steel

Standard Frame	
Silicone over Stainless Steel	EOCS-___ /S
Fluorosilicone over Stainless Steel	EOCS-___ /F

Specify frame and size by choosing the desired prefix from the table.

Example: **EOCS-14 /S**  
Environmental Only Connector-Seal,  
Silicone over Stainless Steel Frame

	MIL-C-26482, 26500, 83723 Series 1 & 3 NAS 1599 "B" & "T" Size	MIL-C-38999		MIL- C-81703 Size	A ±.005"	B +.010" -.005"	C ±.020"	D ±.005"
		1 & 2 Size	3 & 4 Size					
01	8	8			.594"	.562"	.937"	.125"
02				3	.625"	.623"	1.000"	.125"
03	10	9 & 10	9	7	.719"	.687"	1.062"	.125"
04					.798"	.883"	1.200"	.125"
05	12	11 & 12	10 & 11		.812"	.812"	1.156"	.125"
06				12	.812"	.828"	1.200"	.125"
07	14	13 & 14	12 & 13	19	.906"	.947"	1.200"	.125"
08					.928"	1.070"	1.375"	.125"
09	16	15 & 16	14 & 15	27	.969"	1.063"	1.375"	.125"
10					.978"	1.133"	1.437"	.125"
11	18	17 & 18	16 & 17		1.062"	1.187"	1.437"	.125"
12					1.140"	1.325"	1.625"	.125"
13				37	1.187"	1.325"	1.562"	.125"
14	20	19 & 20	18 & 19		1.156"	1.312"	1.563"	.125"
15					1.128"	1.508"	1.825"	.125"
16	22		20 & 21		1.250"	1.437"	1.687"	.125"
17	24		22 & 23		1.375"	1.562"	1.825"	.152"
18					1.392"	1.633"	1.937"	.152"
19				61	1.436"	1.570"	1.825"	.125"
20		25	24 & 25		1.500"	1.682"	1.937"	.152"
21					1.568"	1.830"	2.250"	.152"
22					1.716"	2.030"	2.375"	.173"
23					.753"	.771"	1.100"	.125"
28	32				1.750"	2.062"	2.312"	.173"
29					1.062"	1.250"	1.437"	.125"
32					1.938"	2.186"	2.550"	.173"
33			24 & 25		1.500"	1.682"	1.850"	.152"
34	36				1.938"	2.312"	2.600"	.173"
35					1.750"	1.846"	2.250"	.173"
39					1.187"	1.437"	1.687"	.125"
40					1.437"	1.726"	1.880"	.125"

# EMI & Environmental Connector-Seal (Back-Mount)



Spira's **EMI & Environmental Connector-Seal** gaskets are designed to provide an EMI and Environmental seal in flange-mounted connectors for the life of a system. They provide superior shielding quality and an excellent and durable environmental seal. (Also see *Front-Mount* version.)

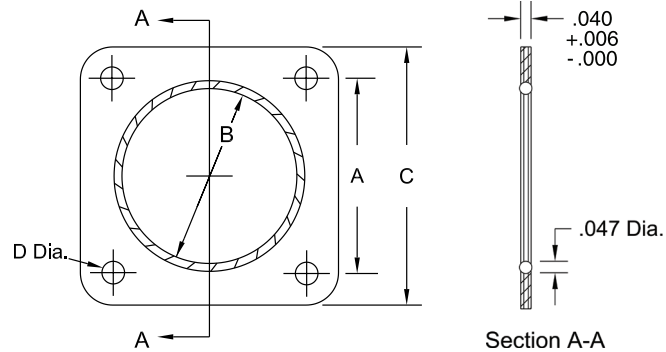

## Application Information

The EMI & Environmental Connector-Seal "ECS" gaskets are made by attaching a Spira-Shield O-Ring gasket to an environmental sealing frame. The frame consists of a stainless steel plate sealed on both sides with vulcanized silicone or fluorosilicone rubber elastomer. The metal plate eliminates cold flow of the environmental sealing elastomer and provides a very durable and reusable gasket.

The "ECS" EMI & Environmental Connector-Seal is designed primarily for back mounting. The shell sizes noted with an asterisk (\*) can be used for both front and back mounting. See the front-mount "FMECS" version on the following pages.

### Materials

See page 59 for material specifications.

**Frame:** Corrosion resistant stainless steel, between silicone or fluorosilicone rubber elastomer. Specify "/S" for Silicone or "/F" for Fluorosilicone.

**Spiral:** Spira-Shield Standard force tin/lead plated beryllium copper gasket.

### Shielding Quality

Connector-Seal gaskets offer shielding quality from 116 to 152 dB. The level is dependent on contact surfaces and may vary depending on your specific application. Refer to Shielding Quality for more complete performance data.

## Available Options

### Plating

See page 60 for material compatibility information.

See table below for spiral plating options.

The gasket is electroplated, 90% tin, 10% lead (edges unplated).

Plating options can be specified by changing the prefix in the part number:

**E:** Edge tin/lead plating (includes edges) for high humidity or salt-fog environments

**IW:** RoHS compliant tin plating (Example: ECS-IW-21 /S)

**EIW:** RoHS compliant edge tin plating for high humidity or salt-fog

### Frame

The default frame is stainless steel sealed on both sides by silicone or fluorosilicone rubber elastomer.

Specify frame and plating options by choosing the desired prefix from the table.

Frame	Elastomer	Tin/Lead Plated Gasket	RoHS Tin Plated Gasket	Edge Tin/Lead Plated Gasket	RoHS Edge Tin Plated Gasket
Elastomer over Stainless Steel	Silicone	ECS-T-__ /S	ECS-IW-__ /S	ECS-E-__ /S	ECS-EIW-__ /S
	Fluorosilicone	ECS-T-__ /F	ECS-IW-__ /F	ECS-E-__ /F	ECS-EIW-__ /F

Not all configurations are stock items. Contact us for availability.

# Ordering Information

EMI & Environmental Connector-Seal gaskets are ordered by the piece.

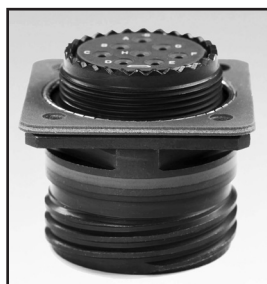
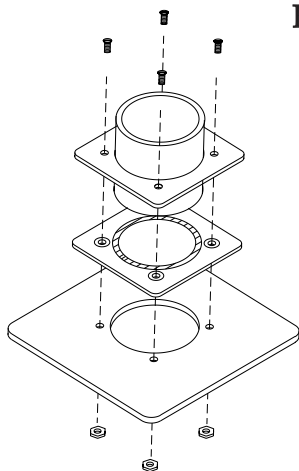

Back Mount ECS

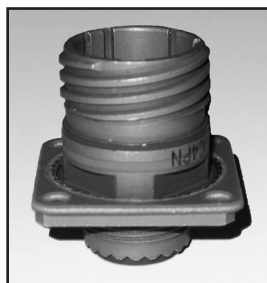

Front Mount ECS

Part Number:

ECS - T - /

Dash No.  
From Table

Gasket Plating

T: Tin  
E: Edge Tin  
IW: RoHS Tin  
EIW: RoHS Edge Tin  
NI: Stainless Steel  
TNI: Tin Stainless Steel  
IWNi: RoHS Tin  
Stainless Steel

Frame Material:

/S: Silicone over Stainless Steel  
/F: Fluorosilicone over Stainless Steel

Dash No.	MIL-C-38999		MIL-C-38999 Series II, MIL-E-26482, MS27472, MS27497	M83723	MS27613	A	B	C	D
	Series I MS27656	Series III							
01			8			0.594	0.448	0.828	0.125
02				8		0.594	0.510	0.828	0.125
03	9*					0.719	0.672	0.958	0.125
04		9				0.719	0.482	0.938	0.125
05			10*	10*		0.719	0.695	0.954	0.125
06	11	11				0.812	0.601	1.031	0.125
07			12	12	12	0.812	0.790	1.031	0.125
08	13	13				0.906	0.719	1.125	0.125
09			14	14	14	0.906	0.885	1.125	0.125
10	15	15				0.969	0.876	1.219	0.125
11			16	16	16	0.969	1.010	1.234	0.125
12	17	17				1.062	0.994	1.312	0.125
13			18	18	18	1.062	1.082	1.328	0.125
14	19	19				1.156	1.112	1.438	0.125
15			20	20		1.156	1.198	1.453	0.125
16	21	21				1.250	1.230	1.562	0.125
17			22	22	22	1.250	1.332	1.562	0.125
18	23	23				1.375	1.349	1.688	0.152
19			24	24	24	1.375	1.452	1.703	0.152
20	25	25				1.500	1.467	1.812	0.152
21					28	1.562	1.710	2.000	0.152
				MS-3412, MIL-DTL 5015 Series II	MIL-C-28840	A	B	C	D
22				8*		0.594	0.510	0.875	0.125
23				10*		0.719	0.635	1.000	0.125
24					11*	0.750	0.760	1.023	0.125
25				12*		0.812	0.760	1.094	0.125
26					13*	0.843	0.885	1.138	0.125
27				14*		0.906	0.885	1.188	0.125
28					15*	0.968	1.072	1.258	0.125
29				16*		0.969	1.010	1.281	0.125
30					17*	1.015	1.135	1.383	0.125
31				18*		1.062	1.135	1.375	0.125
32					19*	1.140	1.322	1.508	0.125
33				20*		1.156	1.260	1.500	0.125
34				22*		1.250	1.385	1.625	0.125
35					23*	1.281	1.510	1.718	0.125
36				24*		1.375	1.510	1.750	0.152
37					25*	1.392	1.635	1.818	0.152
38				28*		1.562	1.760	2.000	0.152
39					29*	1.568	1.885	2.138	0.152
40				32*		1.750	2.010	2.250	0.172
41					33*	1.734	2.073	2.328	0.172
42				36*		1.938	2.260	2.500	0.172
43				40*		2.188	2.510	2.750	0.172
44				44*		2.375	2.760	3.000	0.172
45				48*		2.625	3.010	3.250	0.172

\* The ECS gaskets are designed for back mounting of the connectors. Shell sizes noted with an asterisk (\*) can be used for both front or back mounting. See the FMECS on the following pages for the Front-Mount Connector-Seal gasket.

Custom sizes are also available. Contact us for more information.

Note that the dash numbers and sizes are different for each Connector-Seal gasket: the Environmental Connector-Seal Standard-Mount (ECS), the Front-Mount Environmental Connector-Seal (FMECS) and the EMI-Only version (CS).



# EMI & Environmental Connector-Seal (Front-Mount)



Spira's **Front-Mount EMI & Environmental Connector-Seal** gaskets are designed to provide an EMI & Environmental seal in flange-mounted connectors for the life of a system. They provide superior shielding quality and an excellent and durable environmental seal.

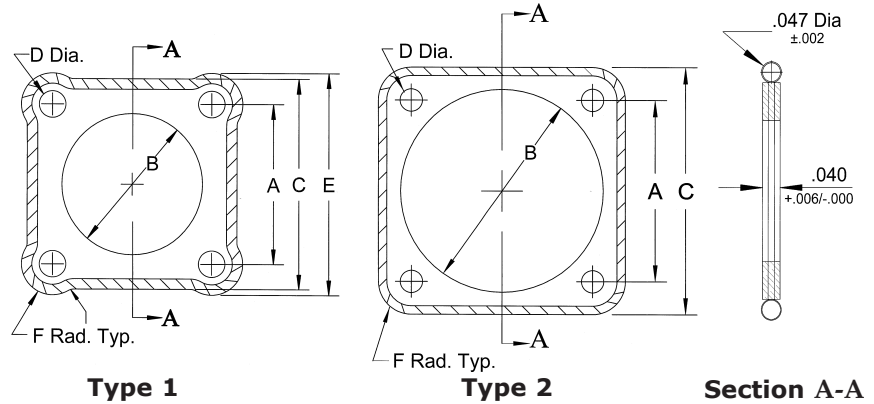

## Application Information

The *Front-Mount "FMECS"* EMI & Environmental Connector-Seal have a Spira-Shield O-Ring gasket on the *outside* of the frame to provide an environmental seal when front mounting the connector. (As shown in the figures on page 26.) The frame consists of a metal plate sealed on both sides with vulcanized silicone or fluorosilicone rubber elastomer. The metal plate eliminates cold flow of the environmental sealing elastomer and provides a very durable and reusable gasket. Please see the previous pages for a more cost-effective back-mount "ECS" EMI & Environmental Connector-Seal.

### Materials

See page 59 for material specifications.

**Frame:** Corrosion resistant Stainless Steel, between silicone or fluorosilicone rubber elastomer. Specify "/S" for Silicone or "/F" for Fluorosilicone.

**Spiral:** Spira-Shield Standard force tin/lead plated beryllium copper gasket.

### Shielding Quality

Connector-Seal gaskets offer shielding quality from 116 to 152 dB. The level is dependent on contact surfaces and may vary depending on your specific application. Refer to Shielding Quality for more complete performance data.

## Available Options

### Plating

See page 60 for material compatibility information.

See table below for spiral plating options.

The gasket is electroplated, 90% tin, 10% lead (edges unplated).

Plating options can be specified by changing the prefix in the part number:

**E:** Edge tin/lead plating (includes edges) for high humidity or salt-fog environments

**IW:** RoHS compliant tin plating (Example: FMECS-IW-11S2 /S)

**EIW:** RoHS compliant edge tin plating for high humidity or salt-fog

### Frame

The default frame is stainless steel sealed on both sides by silicone or fluorosilicone rubber elastomer.

Specify frame and plating options by choosing the desired prefix from the table.

Specify dash number from table on page 26.

Frame	Elastomer	Tin/Lead Plated Gasket	RoHS Tin Plated Gasket	Edge Tin/Lead Plated Gasket	RoHS Edge Tin Plated Gasket
<b>Elastomer over Stainless Steel</b>	Silicone Fluorosilicone	FMECS-T-__ /S FMECS-T-__ /F	FMECS-IW-__ /S FMECS-IW-__ /F	FMECS-E-__ /S FMECS-E-__ /F	FMECS-EIW-__ /S FMECS-EIW-__ /F

Not all configurations are stock items. Contact us for availability.

# Ordering Information

Front Mount EMI/Environmental Connector-Seal gaskets are ordered by the piece.

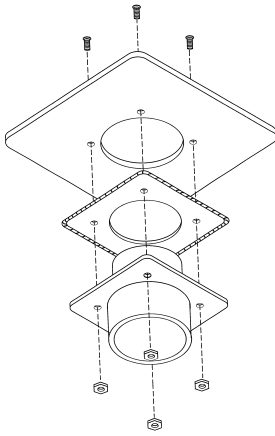

**Front Mount  
Type 1\***

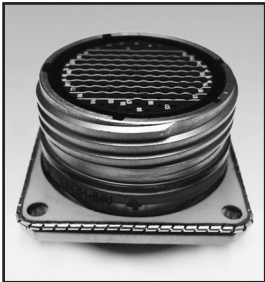

**Front Mount  
Type 2**

**Part Number:**

**FMECS - T - /**

Dash No.  
From Table

**Gasket Plating**

- T: Tin
- E: Edge Tin
- IW: RoHS Tin
- EIW: RoHS Edge Tin
- NI: Stainless Steel
- TNI: Tin Stainless Steel
- IWNI: RoHS Tin Stainless Steel

**Frame Material:**

- /S: Silicone over Stainless Steel
- /F: Fluorosilicone over Stainless Steel

Dash No.	MIL-C-38999					A	B	C	D	E	F
	Series I	Series II	Series III								
03S1	9					0.719	0.666	0.958	0.120	0.999*	0.140
06S1	11					0.812	0.806	1.051	0.120	1.092*	0.140
08S1	13					0.906	0.932	1.145	0.120	1.186*	0.140
10S1	15					0.969	1.057	1.243	0.120		0.137
12S1	17					1.062	1.170	1.336	0.120		0.137
14S1	19					1.156	1.307	1.460	0.120		0.152
16S1	21					1.250	1.432	1.585	0.120		0.168
18S1	23					1.375	1.557	1.710	0.152		0.168
20S1	25					1.500	1.682	1.835	0.152		0.168
01S2		8				0.594	0.563	0.828	0.120	0.874*	0.140
05S2		10				0.719	0.680	0.954	0.120	0.999*	0.140
07S2		12				0.812	0.859	1.047	0.120	1.092*	0.140
09S2		14				0.906	0.984	1.141	0.120	1.186*	0.140
11S2		16				0.969	1.068	1.243	0.120		0.137
13S2		18				1.062	1.193	1.346	0.120		0.142
15S2		20				1.156	1.318	1.471	0.120		0.158
17S2		22				1.250	1.443	1.596	0.120		0.173
19S2		24				1.375	1.570	1.723	0.152		0.174
04S3			9			0.719	0.635	0.948	0.120	1.000*	0.141
06S3			11			0.812	0.760	1.042	0.120	1.094*	0.141
08S3			13			0.906	0.885	1.136	0.120	1.188*	0.141
10S3			15			0.969	1.010	1.254	0.120		0.143
12S3			17			1.062	1.185	1.348	0.120		0.143
14S3			19			1.156	1.260	1.449	0.120		0.147
16S3			21			1.250	1.385	1.575	0.120		0.163
18S3			23			1.375	1.510	1.701	0.150		0.163
20S3			25			1.500	1.635	1.823	0.150		0.162
				MS-3412, MIL- DTL 5015 Series II	MIL-C-28840	A	B	C	D		F
22				8		0.594	0.510	0.875	0.120		0.141
23				10		0.719	0.635	1.000	0.120		0.141
24					11	0.750	0.760	1.023	0.120		0.137
25				12		0.812	0.760	1.094	0.120		0.141
26					13	0.843	0.885	1.138	0.120		0.148
27				14		0.906	0.885	1.188	0.120		0.141
28					15	0.968	1.072	1.258	0.120		0.145
29				16		0.969	1.010	1.281	0.120		0.156
30					17	1.015	1.135	1.383	0.120		0.184
31				18		1.062	1.135	1.375	0.120		0.157
32					19	1.140	1.322	1.508	0.120		0.184
33				20		1.156	1.260	1.500	0.120		0.172
34				22		1.250	1.385	1.625	0.120		0.188
35					23	1.281	1.510	1.718	0.120		0.219
36				24		1.375	1.510	1.750	0.150		0.188
37					25	1.392	1.635	1.818	0.150		0.213
38				28		1.562	1.760	2.000	0.150		0.219
39					29	1.568	1.885	2.138	0.150		0.285
40				32		1.750	2.010	2.250	0.170		0.250
41					33	1.734	2.073	2.328	0.170		0.297
42				36		1.938	2.260	2.500	0.170		0.281
43				40		2.188	2.510	2.750	0.170		0.281
44				44		2.375	2.760	3.000	0.170		0.313
45				48		2.625	3.010	3.250	0.170		0.313

\* Type 1 gaskets have an E dimension to provide sufficient environmental sealing on smaller sizes. See drawing on page 25.

Custom sizes are also available. Contact us for more information.

# EMI-Only Connector-Seal

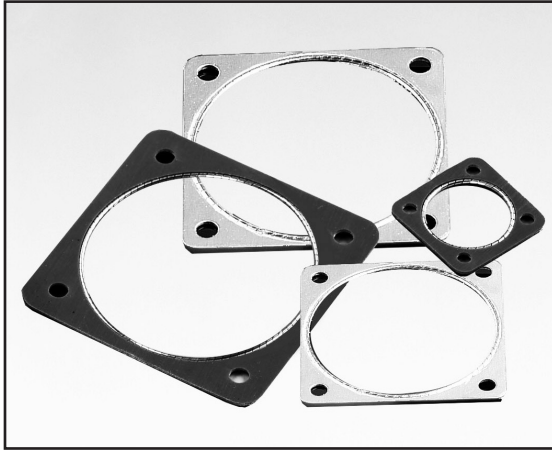

Spira's **EMI-Only Connector-Seal** gaskets are designed to provide an EMI seal in flange-mounted connectors for the life of a system. These gaskets are extremely durable, and have achieved up to 1,000 insertions in actual use.

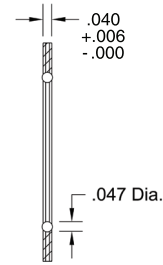
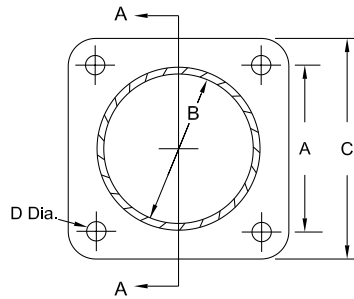

Section A-A  
**CS Series**

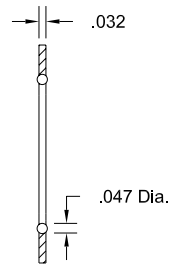

Section A-A  
**SSCG Series**

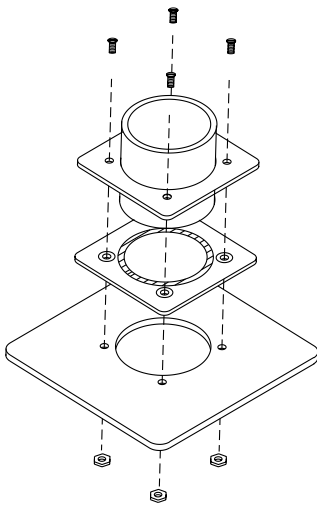

**CS Series: Silicone or Fluorosilicone on a Stainless Steel Frame**

**CS - T - / -**

Gasket Plating  
 T: Tin  
 E: Edge  
 IW: RoHS  
 EIW: RoHS Edge  
 Dash No. From Table  
 Elastomeric Sealing  
 /S: Silicone  
 /F: Fluorosilicone

**Original SSCG Series: Aluminum Frame (Old style - replaced by CS)**

**SSCG - T - - O**

Gasket  
 T: Spira-Shield  
 B: Enduro-Shield  
 Dash No. From Table

Dash No.	For Use with Connectors			A ±.005"	B +.010" -.005"	C ±.020"	D +.010" -.005"	
	MIL-C-26482, 26500, 83723 Series 1 & 3 NAS 1599 "B" & "T" Size	MIL-C-38999						MIL-C-81703 Size
		1 & 2 Size	3 & 4 Size					
01	8	8		.594"	.562"	.937"	.125"	
02				.625"	.623"	1.000"	.125"	
03	10	9 & 10	9	.719"	.687"	1.062"	.125"	
04				.798"	.883"	1.200"	.125"	
05	12	11 & 12	10 & 11	.812"	.812"	1.156"	.125"	
06				.812"	.828"	1.200"	.125"	
07	14	13 & 14	12 & 13	.906"	.947"	1.200"	.125"	
08				.928"	1.070"	1.375"	.125"	
09	16	15 & 16	14 & 15	.969"	1.063"	1.375"	.125"	
10				.978"	1.133"	1.437"	.125"	
11	18	17 & 18	16 & 17	1.062"	1.187"	1.437"	.125"	
12				1.140"	1.325"	1.625"	.125"	
13				1.187"	1.325"	1.562"	.125"	
14	20	19 & 20	18 & 19	1.156"	1.312"	1.563"	.125"	
15				1.238"	1.508"	1.825"	.125"	
16	22		20 & 21	1.250"	1.437"	1.687"	.125"	
17	24		22 & 23	1.375"	1.562"	1.825"	.152"	
18				1.392"	1.633"	1.937"	.152"	
19				1.436"	1.570"	1.825"	.125"	
20		25	24 & 25	1.500"	1.682"	1.937"	.152"	
21				1.568"	1.830"	2.250"	.152"	
22				1.716"	2.030"	2.375"	.173"	
23				.753"	.771"	1.100"	.125"	
28	32			1.750"	2.062"	2.312"	.173"	
29				1.062"	1.250"	1.437"	.125"	
32				1.938"	2.186"	2.550"	.173"	
33			24 & 25	1.500"	1.682"	1.850"	.152"	
34	36			1.938"	2.312"	2.600"	.173"	
35				1.750"	1.846"	2.250"	.173"	
39				1.187"	1.437"	1.687"	.125"	
40				1.437"	1.726"	1.880"	.125"	

Outer Conductive Spiral:  
Tin/Lead Plated Beryllium Copper



Resilient Inner Core:  
Solid Silicone (**SSCG only**)

## Application Information

The “CS” EMI-Only Connector-Seal is a more durable, cost effective replacement of Spira’s original Connector-Seal (“SSCG”) and can be either back or front-mounted. The CS EMI-Only gasket is similar to the EMI & Environmental Connector-Seal (ECS), but due to frame dimensions it **does not provide Environmental sealing**.

When choosing a gasket, select an inside diameter that easily clears the connector barrel. The shielding is achieved by making contact between the two joint surfaces, not by touching the barrel. The older SSCG gaskets can still be ordered if desired.

### Materials

See page 59 for material specifications.

**CS Frame:** Silicone (/S) or Fluorosilicone (/F) sealing over a stainless steel frame.

**CS Spiral:** Spira-Shield standard force tin/lead plated beryllium copper.

**SSCG Frame:** Chem-film plated aluminum (old style, replaced by CS)

**SSCG Spiral:** Enduro-Shield moderate force tin/lead plated beryllium copper.

**SSCG Core:** Cured silicone adhesive.

(See *Options* for RoHS compliance).

### Shielding Quality

EMI Connector-Seal gaskets offer shielding quality from 116 to 152 dB. The shielding quality may vary depending on your specific application. Refer to Shielding Quality for more complete performance data.

### Compression Force

Optimal compression of the gasket is 25% of the diameter of the spiral. The compression force stated is approximate. When installing the gasket, care must be taken to clear the mounting pins one at a time.

**CS Series:** ~30 pounds per linear inch compression force required.

**SSCG Series:** ~10 pounds per linear inch compression force required.

## Available Options

### Plating

See page 60 for material compatibility information.

The gasket is electroplated, 90% tin, 10% lead per AMS-P-81728 (edges unplated). Plating options can be specified by adding a prefix before the part number:

**E:** Edge tin/lead plating (includes edges) for high humidity or salt-fog environments

**IW:** RoHS compliant tin plating (Example: **CS-IW-20 /S**)

**EIW:** RoHS compliant edge tin plating for high humidity or salt-fog

### SSCG Core Material

The SSCG uses a Spira-Seal gasket with a standard core of solid silicone adhesive. A special core can be specified by adding an option to the end of the part number:

**-F:** Fluorosilicone (Example: **CS-T-16 /F**)

**-O:** Silicone that meets outgassing requirements

**-Z:** Silicone which is a non-acetic acid adhesive (per MIL-A-46146)

### Frame

Specify frame and other options by choosing the desired prefix from the table.

Example:  
**CS-E-14 /S**

EMI Connector-Seal  
Edge tin/lead plated  
gasket, Silicone frame

The frame on our CS series gaskets is stainless steel sealed on both sides by silicone or fluorosilicone elastomeric material. The SSCG series gaskets have a chem-film plated aluminum frame. The CS gaskets are still **EMI-only protection** due to the sizing. Please see the previous page for environmental sealing if required. Not all configurations are stock items. Contact us for availability.

Frame	Options	Tin/Lead Plated Gasket	RoHS Tin Plated Gasket	Edge Tin/Lead Plated Gasket	RoHS Edge Tin Plated Gasket
<b>Elastomeric Frame Material</b>	Silicone Fluorosilicone	CS-T-__ /S CS-T-__ /F	CS-IW-__ /S CS-IW-__ /F	CS-E-__ /S CS-E-__ /F	CS-EIW-__ /S CS-EIW-__ /F
<b>Chem-Film Aluminum</b>	n/a	SSCG-T-__ -O	IWSSCG-T-__ -O	ESSCG-T-__ -O	EIWSSCG-T-__ -O

Specify dash number from table on page 27.





# The "SPIRA Advantage" in Honeycomb Filters

Spira's family of exceptional honeycomb filters includes our NEW Shielded Fan Filter, as well as our popular Spira-Cell and Brass-Cell Shielded Air Vent Filters. All Spira honeycomb filters include the "Spira Advantage" as described below. See the following pages for more specifications.

## Spira's Patented Process

All Spira-Cell Air Vent Filters and Fan Filters include our patented "blending" process of the aluminum honeycomb panel that provides high and reliable levels of shielding. Our filters also include the use of epoxy which mechanically bonds the honeycomb panel to the frame and the use of our patented spiral EMI gasket, which ensures an excellent, long-lasting EM bond between the panel and the frame.

## Shielding Effectiveness

The shielding effectiveness graphs illustrate the shielding of  $1/8''$  cell by  $1/4''$  thick honeycomb panels including: (A) the level of shielding obtained from a typical honeycomb panel; (B) the shielding from a panel which has been processed using our patented blending process; and (C,D) the shielding obtained from tin plated honeycomb panels, where most of the incidental contact points across the epoxy joint were removed from one of the panels during the pre-plating cleaning process (D).

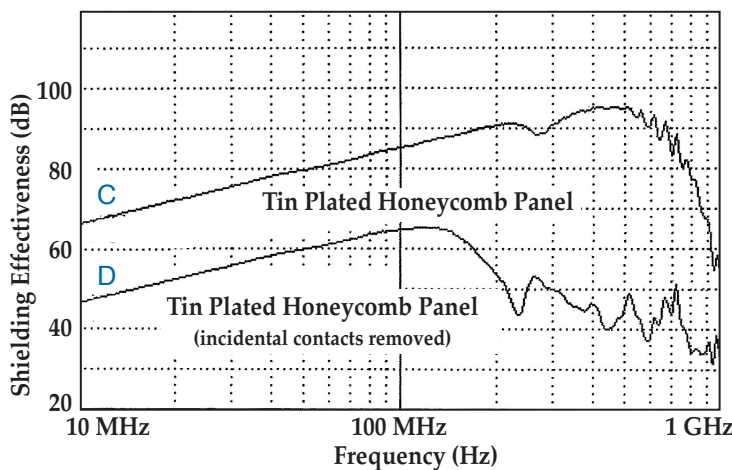
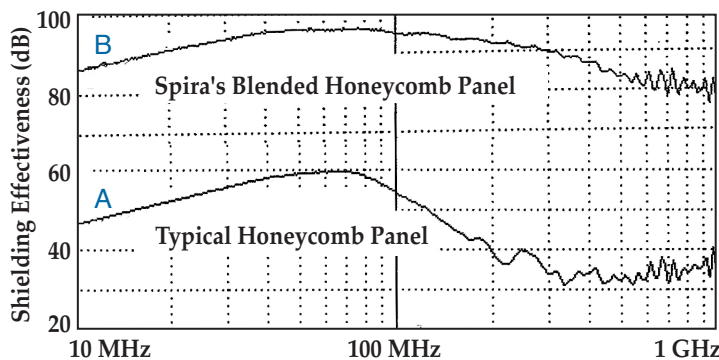

*This data is representative of the test data we have obtained. Your results will vary depending on the applicable variables.*

### Microscopic Photos of Honeycomb Panel Cells

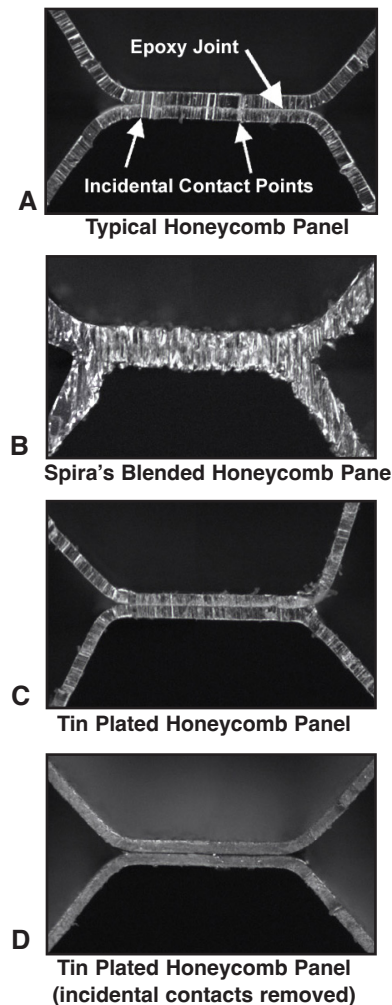



# Shielded Air Vent Honeycomb Filters

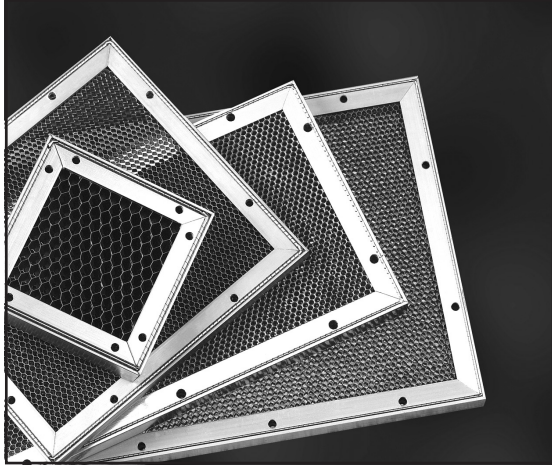

Spira's Shielded Air Vent Honeycomb Filters are designed to provide consistent and reliably high levels of shielding while allowing cooling air to penetrate an electrical equipment cabinet. Air vent filters are available in Spira-Cell or Brass-Cell for different applications and levels of shielding. (See page 35 for our Shielded Honeycomb Fan Filters).

## Design Advantages (All Types)

Due to their construction and materials, our honeycomb filters offer several cost-effective advantages over the other honeycomb filters on the market.

**Competitive Cost** A fully automated machine is used to cut the frame to size. This machine is coupled with several automated and semi-automated processes used to apply epoxy to the frame/honeycomb panel interface for mechanical strength of the filter, and to install the electromagnetic (EM) bonding spiral gasket to the extrusion. These machines and processes significantly reduce the time required to manufacture and assemble the filters, and we pass that savings on to our customers.

### **Shielding Advantage**

The honeycomb panels we use offer high, reliable levels of shielding. The Brass-Cell uses brass foils soldered together which provide extremely high, reliable shielding. The aluminum panels used for Spira-Cell filters are processed using our patented blending process that ensures a reliable conductive path across the epoxy joints of the honeycomb cells. Tests have shown as much as a 40 dB improvement for single panel filters and 70 dB improvement for double panel filters over the use of panel material which has not been processed. See pages 29 and 32 for complete performance data.

### **Reliable Joint Surfaces**

We use 6061 aluminum for our frame members because of its high surface conductivity and corrosion resistant properties. We augment this with tin or tin/lead plating (when specified) to meet higher levels of shielding and/or corrosion compatibility requirements. Chemical film plating can also be employed when the high levels of shielding associated with tin plating are not required. Any plating is done prior to assembly which guarantees that the acids and other chemicals used in the pre-plating etch process are totally removed from the components, thus ensuring a long, reliable life of the filter.

### **Spiral Bonding**

Spira EMI gasket materials are used to obtain an excellent, reliable frame-to-chassis bond on all types of filters. The gaskets are also employed for the honeycomb panel-to-frame electromagnetic bond on the Spira-Cell and Brass-Cell filters. The spiral gaskets are employed for the purpose of absorbing thermal expansion and contraction, shock, and vibration to insure an excellent electromagnetic bond throughout the life of the filter.

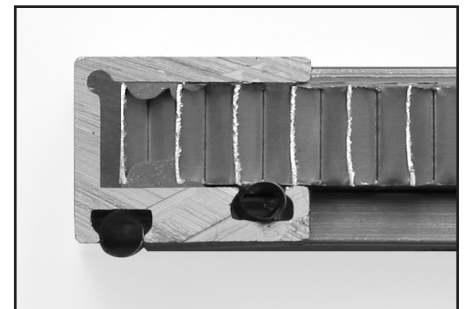

*The only shielded air vent filter with spiral bonding.  
(1 panel configuration shown)*

## Available Options (All Types)

### **Frame Style**

The honeycomb panel frames are used to hold the honeycomb panel material in place and to reference the honeycomb panels to equipment chassis ground potential. The frame comes with a spiral EMI gasket for panel bonding on either Spira-Cell or Brass-Cell filters.

### **Spiral-Bonding Frame**

The extrusions used for the Spira-Cell and Brass-Cell filters have built-in dovetail grooves. These grooves are used to hold the spiral EM bonding gasket in place during the manufacturing process and allow the gasket to move unrestricted during compressed applications. This unrestricted movement allows the gasket to absorb movement of the joint surfaces during thermal expansion and contraction, vibration and shock. This results in reliable EM bonding between the honeycomb panel and the frame throughout the life of the filter.

*"C" Frame Spiral Bonding  
(2 panel configuration shown)*

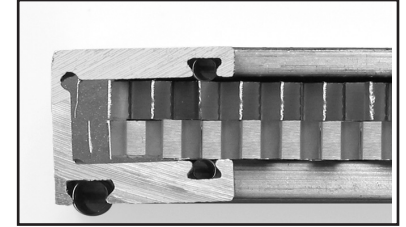

*Dovetail groove holds gasket in place during manufacturing.*

### **Cell Width**

All of the standard filters use a 1/8" cell. Other cell sizes are available through special order. Contact us for availability.

### **Cell Thickness**

The standard panel thicknesses are 1/8" (Aluminum only), 1/4", 1/2" or 1". Contact us for availability.

### **Threaded Inserts**

Filters can be made either with through holes of varying sizes or fitted with threaded inserts. For cost efficiency, we recommend even spacing of holes. Threaded inserts are not available on the 1/8" thick panels.

*Filters are available in RoHS compliant versions on request.*

Please see the Ordering Information section on page 33. Items are custom order. Contact us for availability, assistance and custom quotes.

## Spira-Cell

The Spira-Cell filter is a high reliability air vent filter supplying moderate to high levels of shielding at a relatively low cost. It features an EMI gasket to achieve the honeycomb panel-to-frame EM bond. It comes in both single and double panel configurations with a 6061-T4 aluminum frame and stainless steel gasket or tin plated frame with tin plated stainless steel gasket for the EM bond between the panel and frame and frame-to-chassis. A version is also available for high humidity and salt spray environments.

## Brass-Cell

The Brass-Cell filter gets its name by using brass honeycomb panels. The brass foil is soldered together ensuring consistent, reliable shielding of the filter. The filter offers a reliable, high level of shielding at a relatively low cost. The Brass-Cell filter consists of a tin plated aluminum frame, tin plated stainless steel gasket and brass honeycomb panels. The filter is designed to operate in a relatively low humidity environment due to potential material incompatibilities. A version is also available for high humidity and salt spray environments.

*Filters are available in RoHS compliant versions on request.*

## Salt-Fog

Filters are available in Salt-Fog compliant versions on request.

The high humidity/salt spray versions use our edge tin/lead plated beryllium copper gaskets and are available in the following configurations:

**Spira-Cell:** Tin plated aluminum frame and honeycomb panel.  
(or chem-film plated for "light" salt-fog.)

**Brass-Cell:** Tin plated brass honeycomb panel with tin plated aluminum frame.  
RoHS compliant versions also available on request.

## Shielding Effectiveness of Shielded Air Vent Honeycomb Filters

The shielding effectiveness testing of Spira's honeycomb filters is performed by generating an electromagnetic field through a hole in an enclosure and recording the field strength. The honeycomb filter under test is then attached to the enclosure and a second field strength measurement is recorded. The shielding effectiveness is the difference in the recorded field strength readings in dB.

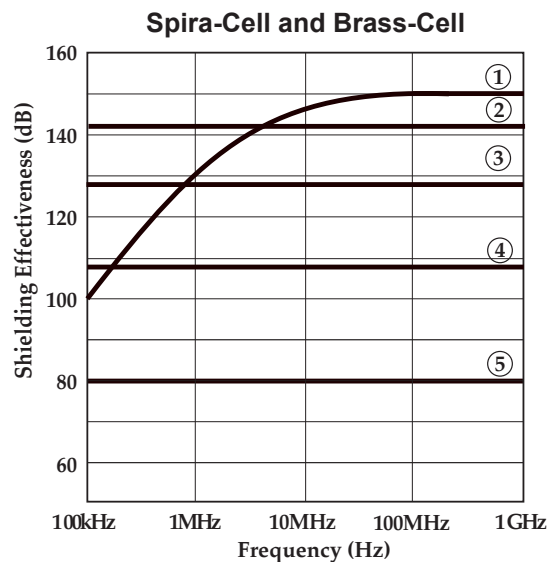

1. Threshold Test Limit
2. Brass-Cell, 1/8" cell x 1" deep
3. Brass-Cell, 1/8" cell x 1/2" deep;  
Spira-Cell, 2 panel, 1/8" cell x 1/4" deep
4. Brass-Cell, 1/8" cell x 1/4" deep;  
Spira-Cell, 2 panel, 1/8" cell x 1/8" deep
5. Spira-Cell, 1/8" cell x 1/4" deep

This data is representative of the test data we have obtained. Your results will vary depending on the applicable variables.

## Static Pressure Drop Versus Air Speed

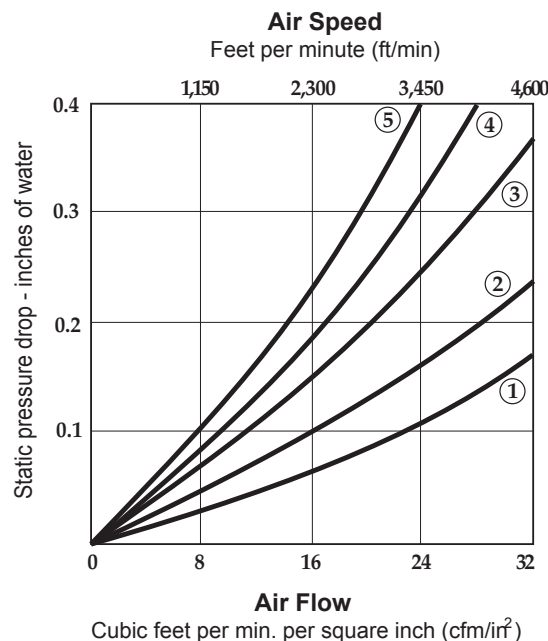

1. 1/8" x 1/8" aluminum
2. 1/8" x 1/4" aluminum
3. 2 panel 1/8" x 1/8" aluminum & Brass Cell 1/8" x 1/4"
4. 2 panel 1/8" x 1/4" aluminum & Brass Cell 1/8" x 1/2"
5. Brass Cell 1/8" x 1"

# Honeycomb Filter Specifications

If you would like assistance or any custom configurations, contact us with your requirements. RoHS compliant versions are available on request.

Honeycomb Filter Options and Shielding					
Type of Filter	Panel & Frame Options	Panel Thickness			
		1/8"	1/4"	1/2"	1"
<b>Spira-Cell</b> • Gasket inside Frame	1 Aluminum Panel 2 Aluminum Panels Tin Plated Frame	60dB 110dB	80dB 130dB	80dB --	-- --
<b>Spira-Cell, Salt-Fog</b>	1 Aluminum Panel Tin Plated Frame & Panel 2 Aluminum Panels Tin Plated Frame & Panel	60dB 110dB	80dB 130dB	80dB --	-- --
<b>Spira-Cell, "Light" Salt-Fog</b>	1 Aluminum Panel Chem-Film Frame & Panel 2 Aluminum Panels Chem-Film Frame & Panel	60dB 90dB	80dB 90dB	80dB --	-- --
<b>Brass-Cell</b>	1 Brass Panel Tin Plated Frame	--	110dB	130dB	140dB
<b>Brass-Cell, Salt-Fog</b>	1 Brass Panel, Tin Plated Frame & Panel	--	110dB	130dB	140dB

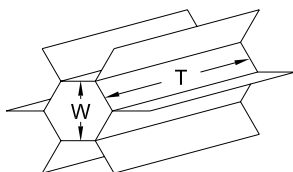

Note: The shielding specified (in dB) is typical of the data we have obtained. Results may vary depending on application. See below for ordering information and page 32 for complete performance data.

W = Honeycomb panel cell width = 1/8" standard. Other cell sizes are available through special order.  
T = Panel Thickness as shown above. The filter thickness will double for 2 panel configurations.

Custom and RoHS compliant Honeycomb Filters are available on request. Contact us for more information.

## Ordering Information

To order, please send a drawing and specify the following information:

### 1. Size of Filter

- Length and Width

### 2. Type of Honeycomb Panel

- Aluminum or Brass

### 3. Thickness of Honeycomb Panel

- 1/8" (Aluminum only), 1/4", 1/2", or 1" (Brass only)

### 4. Number of Honeycomb Panels

- One or Two Panels

### 5. Plating and Environmental Concerns

- No Plating, Salt-Fog, or Max Shielding (Specify RoHS if needed.)

### 6. Mounting Hole Information

- Quantity of Holes
- Location of Holes
- Through Holes or Threaded Inserts
- Hole or Thread Size

### 7. Outside Spiral Selection

- Spira-shield (standard)
- Optional Flexi-Shield adds extra protection for the spiral gasket during handling.

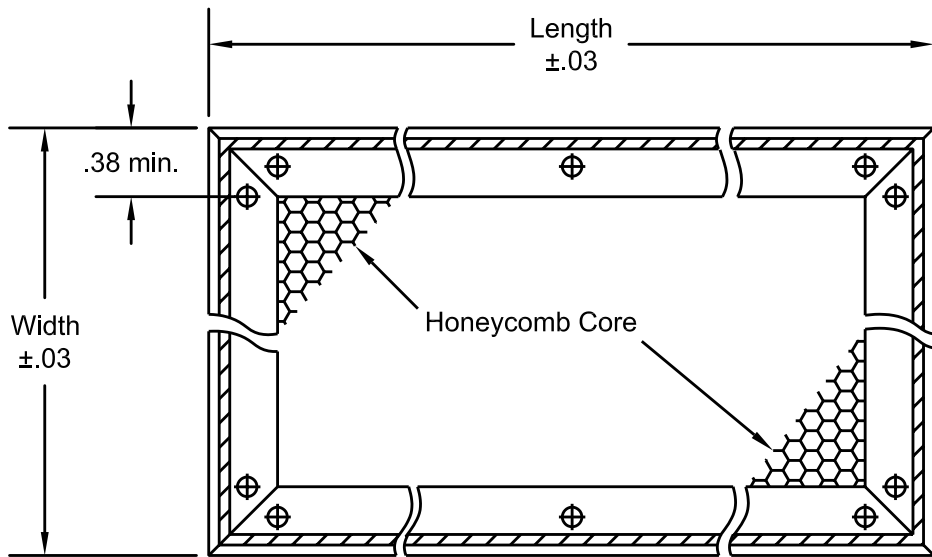

Standard Sizes	
Holes	Screw Sizes
.120"	4-40
.147"	6-32
.173"	8-32
.204"	10-24

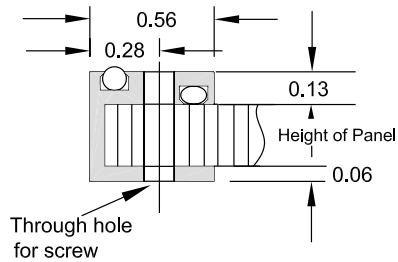

Single panel Spira-Cell or Brass-Cell with through holes

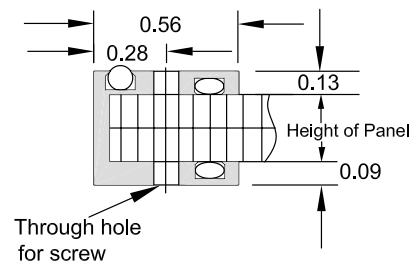

2 panel Spira-Cell with through holes

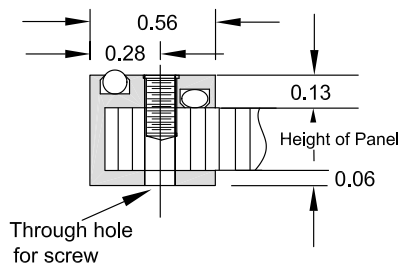

Single panel Spira-Cell or Brass-Cell with threaded inserts

Standard tolerances are:  
 XX +/- .03  
 XXX +/- .015  
 Unless noted otherwise.

All dimensions in inches.



# Shielded Honeycomb Fan Filters

Spira's Shielded Fan Filters provide a high and reliable level of shielding at very cost effective and competitive prices. They include the "Spira Advantage" as described on page 29, using our patented honeycomb blending process and patented spiral Flexi-Shield gasket to provide exceptional EMI shielding and EM bond.

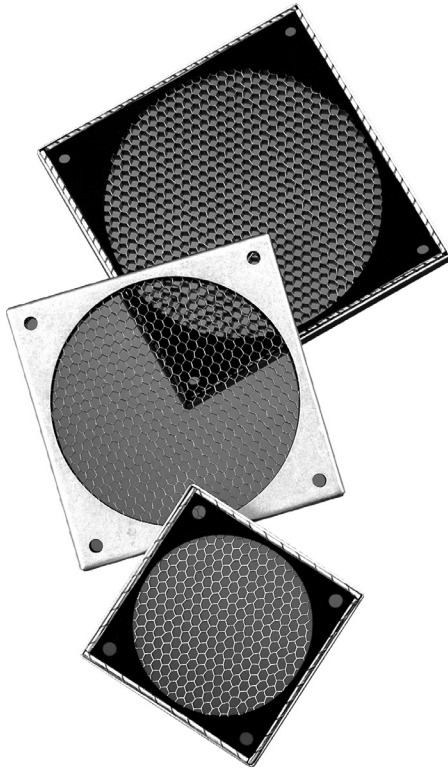

Fan Filter Part Number	Fan Size	A ±.030	B ±.010	C ±.015	D ±.015	F ±.020	G* ±.020
HF-38mm-25	38mm	1.631	1.181	1.36	.150	.319	.345
HF-38mm-50	38mm	1.631	1.181	1.36	.150	.569	.595
HF-40mm-25	40mm	1.71	1.260	1.38	.150	.319	.345
HF-40mm-50	40mm	1.71	1.260	1.38	.150	.569	.595
HF-60mm-25	60mm	2.50	1.970	2.17	.170	.319	.345
HF-60mm-50	60mm	2.50	1.970	2.17	.170	.569	.595
HF-80mm-25	80mm	3.34	2.810	3.01	.170	.319	.345
HF-80mm-50	80mm	3.34	2.810	3.01	.170	.569	.595
HF-92mm-25	92mm	3.78	3.250	3.45	.170	.319	.345
HF-92mm-50	92mm	3.78	3.250	3.45	.170	.569	.595
HF-120mm-25	120mm	4.82	4.125	4.50	.170	.319	.345
HF-120mm-50	120mm	4.82	4.125	4.50	.170	.569	.595

Custom sizes are available on request. Contact us for more information.  
\* Dimension G is for reference only

## Filter Sizes

Fan Filters are compatible with 38, 40, 60, 80, 92 and 120mm fans or can be made in custom sizes on request.

## Cell Size

The filters use 1/8" cell by 1/4" or 1/2" thick aluminum honeycomb panels.

## Frame

The frame is made from chem-film plated 6061-T4 aluminum.

## Spiral Material

The filters include a Flexi-Shield tin/lead plated beryllium copper gasket in standard force. A RoHS compliant version is available on request. The die-cut is commercial grade neoprene sponge.

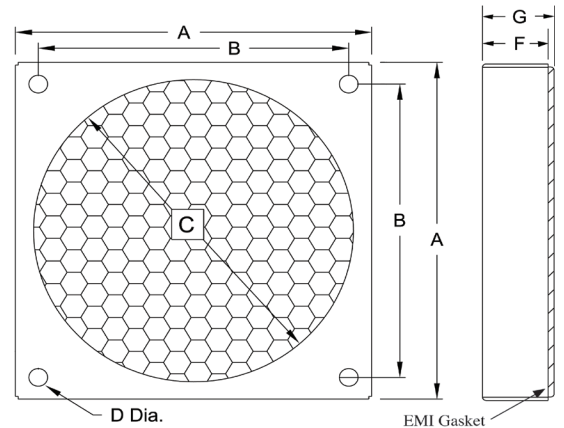

## Salt-Fog Option

A salt-fog version is available on request which includes our Flexi-Shield edge tin/lead plated beryllium copper gasket. The honeycomb panel is tin plated and frame is chem-film plated (or tin plated on request). A RoHS compliant version is available on request.

## Shielding Effectiveness

This graph illustrates that our Fan Filters with the "Spira Advantage" can provide up to 80dB of shielding at 1GHz!

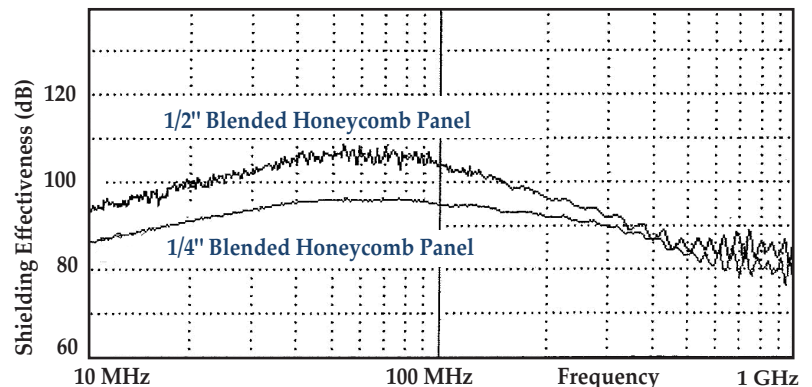

# Dovetail Groove Cutters

Dovetailed grooves are recommended since they hold the gaskets in place and allow the gaskets to expand laterally as they are deflected without constraining the sides.

## Manufacturing Considerations

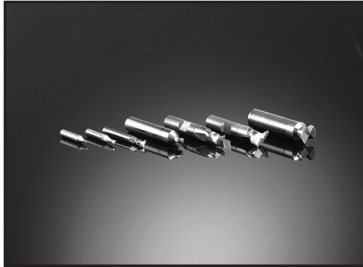

To use the groove properly, care must be exercised during its manufacture.

- The flatness between the bottom of the groove and top surface must be held flat within  $\pm .001"$ . This can be easily achieved by taking a fly-cut on the surface prior to milling the groove. **Note:** do not remove the part from the mill between making the fly-cut and milling the groove.
- In milling the groove, a regular o-ring groove using the dimensions of "W" and "L" must be made first, then finished up with a dovetail cutter.
- To deburr use a Scotch Brite pad (a deburring knife will destroy the "W" tolerance).

## Materials

These groove cutters are custom cut two-fluted end mill, made of Carbide. The standard length is between 1.25"-2.0". Specific lengths are available on request. Not all configurations are stock items. Contact us for availability.

EMI Gasket

Spiral Gaskets		Recommended Mounting Dimensions			Dovetail Cutter Dimensions			
Cutter P/N	Use on Gasket P/N*	L +.002" -.000"	G +.007" -.005"	W +.000" -.002"	n +.000" -.002"	g +.005" -.003"	v +.000" -.002"	Shank Dia.
GC-1-02-C	-02	.023"	.046"	.033"	.024"	.046"	.027"	.1875
GC-1-03-C	-03	.035"	.063"	.045"	.037"	.063"	.035"	.1875
GC-1-04B-C	-04	.046"	.094"	.060"	.046"	.094"	.050"	.1875
GC-1-.070-C	-.070	.053"	.094"	.067"	.054"	.094"	.055"	.1875
GC-1-05B-C	-05	.059"	.109"	.075"	.060"	.109"	.063"	.1875
GC-1-06-C	-06	.070"	.125"	.090"	.072"	.125"	.076"	.1875
GC-1-.103-C	-.103	.077"	.141"	.099"	.078"	.141"	.085"	.1875
GC-1-07B-C	-07	.082"	.156"	.105"	.080"	.156"	.095"	.1875
GC-1-08-C	-08	.094"	.171"	.121"	.097"	.171"	.101"	.1875
GC-1-.139-C	-.139	.104"	.187"	.134"	.114"	.187"	.106"	.1875
GC-1-09-C	-09	.105"	.187"	.136"	.106"	.187"	.120"	.1875
GC-1-11-C	-11	.128"	.234"	.165"	.130"	.234"	.145"	.1875
GC-1-12-C	-12	.140"	.250"	.181"	.148"	.250"	.145"	.3750
GC-1-16B-C	-16	.185"	.343"	.240"	.185"	.343"	.230"	.3750
GC-1-20-C	-20	.234"	.422"	.300"	.234"	.406"	.270"	.5000
GC-1-24-C	-24	.280"	.500"	.364"	.281"	.500"	.334"	.5000
GC-1-32-C	-32	.375"	.656"	.485"	.378"	.656"	.438"	.6875
<b>"D" Multi-Seal Groove Cutters</b>								
DGC-1-04-C	-0421	.046"	.187"	.138"	.052"	.187"	.118"	.1875
DGC-1-06-C	-0632	.070"	.250"	.180"	.075"	.250"	.160"	.3750
DGC-1-08B-C	-0842	.094"	.313"	.240"	.087"	.313"	.230"	.3750
DGC-1-12-C	-1263	.140"	.500"	.367"	.146"	.500"	.337"	.5000
DGC-1-16-C	-1684	.188"	.625"	.485"	.193"	.625"	.455"	.6250

\* Cutter dash numbers correspond one-on one to all Spira-Shield, Ultra Quick Shield, Quick-Shield, Flexi-Shield, Enduro-Shield & "D" Multi-Seal dash numbers. Example: SS-08 uses a GC 1-08-C cutter.

See page 51 for details on groove mounting techniques.

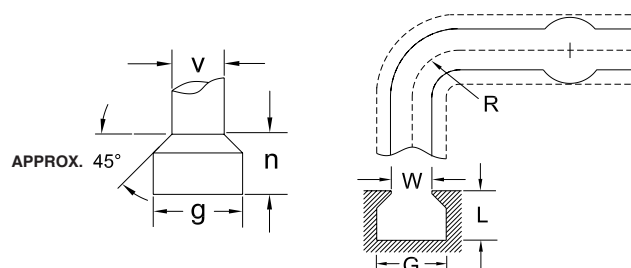

NOTE: The top opening (W) depth is .005"-.010" depending on L dimension.

R= 1½ times the diameter of spiral\* gaskets.

R= 1½ times the "E" dimension of "D" Multi-Seal gaskets.

Most of Spira's gaskets can be customized to meet your needs exactly. Below are the common configurations. If you have another type of gasket in mind, please contact us. We will gladly review your gasket design for feasibility before you finalize it.

## O-Rings

### **Application Information**

O-rings are made using a standard or custom size groove mounted Spira gaskets. O-rings can be used either in circular or rectangular groove applications. We assemble the o-rings either by winding one end of the spiral into the other and soldering (Spira-Shield and Quick-Shield) or using adhesive (Enduro-Shield, Flexi-Shield and "D" Multi-Seal).



When installing a "D" Multi-Seal o-ring into a rectangular groove, put the corners in first, then press the gasket into the straight sections of the groove. We recommend a corner radius of  $1 \frac{1}{2}$  times the diameter of the spiral or width of the "D" Multi-Seal gasket.

### **Available Options**

Custom o-rings can be made from several types of Spira gaskets:

- Spira-Shield
- Quick-Shield
- Ultra Quick-Shield
- Flexi-Shield (See O-Rings for standard sizes)
- Enduro-Shield (See O-Rings for standard sizes)
- "D" Multi-Seal

### **Ordering Information**

Please contact us or send a sketch or drawing which includes the spiral part number, the inside diameter (ID) of the o-ring and the tolerance on the ID.

## Die-cut Gaskets

### **Application Information**

Die-cut gaskets are made by stamping out a piece of rubber and then attaching one of our types of spiral to it. Die-cut gaskets are very economical for high volume applications. They also allow unusual shapes to be sealed more easily. Spiral can be placed inside or outside so the rubber can be correctly oriented to achieve environmental sealing.

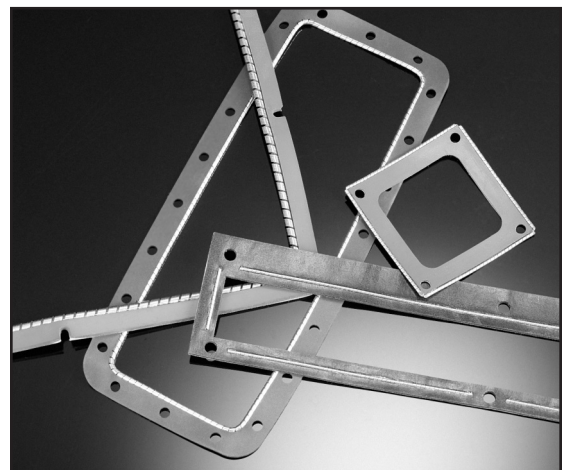

**Available Options**

Die-cut gaskets can be made using any type of spiral and many types of rubber including those shown below. Other types may be available. Please contact us for more information.

- EPDM
- Neoprene Sponge (adhesive backing mandatory)
- Silicone Sponge (adhesive backing available)
- Solid Silicone (adhesive backing available)
- Solid Fluorosilicone

**Ordering Information**

Please contact us with your requirements or send a sketch or drawing (please include tolerances). For solid rubber, we recommend that the rubber thickness be approximately 75% of the diameter of the spiral. For sponge rubber, we recommend the rubber thickness be approximately the same as the diameter of the spiral.

## Framed Gaskets

**Application Information**

Framed gaskets are made by forming Spira-Strip, Quick-Strip or Basic Multi-Seal into a rectangle to your specifications. The corners are miter cut and glued. The spiral can be attached before cutting the corners (90 degree corners) or after (radius on the corners).

**Available Options**

Framed gaskets can be made using the following types of Spira gaskets:

- Spira-Strip
- Quick-Strip
- Basic Multi-Seal

**Ordering Information**

Please contact us with your requirements or send a sketch or drawing (please include tolerances). Framed gaskets are ordered by the piece.

## Air Vent Honeycomb Filters

**Application Information**

Shielded Air Vent Honeycomb Filters are designed to provide shielding while allowing cooling air to penetrate an electrical equipment cabinet. Many custom options are available (some shown below). For standard configurations, please refer to Shielded Air Vent Honeycomb Filters.

**Available Options**

Some of the available custom options include:

- Dust filter
- Round filters
- Custom extrusion frame

**Ordering Information**

Please contact us with your requirements or send a sketch or drawing (please include tolerances). Honeycomb filters are ordered by the piece.

**Note:** Honeycomb Fan Filters also come in custom sizes. Please see page 35.



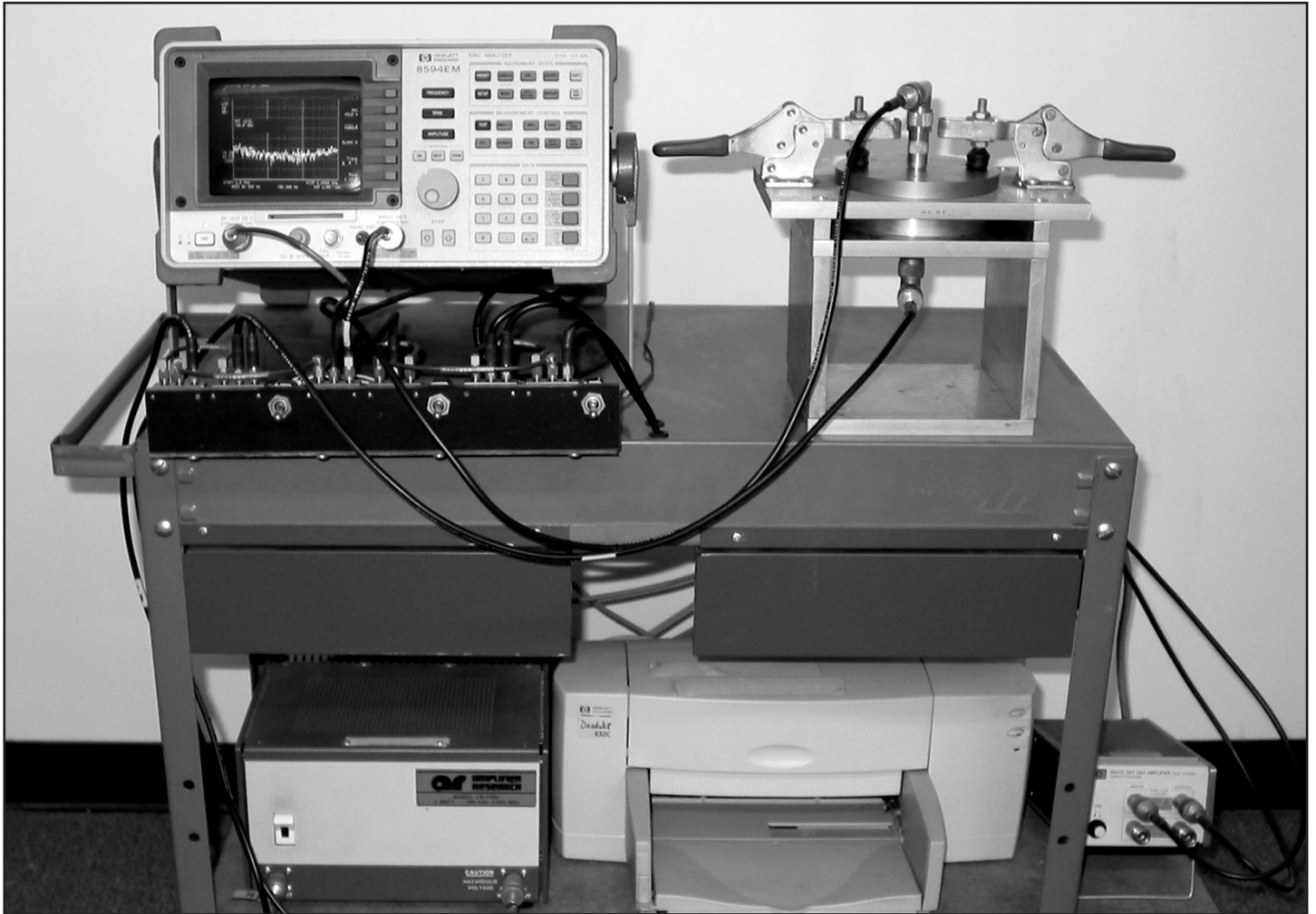

## Spira's Z<sub>T</sub> Test Fixtures

Spira's Z<sub>T</sub> Fixtures offer an inexpensive and reliable means of testing the shielding quality of EMI gaskets and gasketed joints where the testing is consistent with the SAE ARP-1705 standard. The fixtures are intended for use by: (1) gasket manufacturing companies for developing new products and to perform quality assurance testing on their products; (2) the users of gaskets for selecting gaskets and joint surfaces to comply with their system's radiated requirements; and (3) by the users' Quality Assurance departments to certify gasket products. The standard fixtures are delivered with gold plated joint surfaces (gold plated base plate and contact plate) for quality assurance testing of EMI gaskets. The base and contact plates are available in a variety of materials and finishes for engineering evaluation testing.

### **ZT-1000 Fixture**

This fixture is designed to test relatively small samples of a gasketed joint as illustrated. The maximum outer diameter of the circular gasket tested is 3.5 inches (89 mm) with a maximum thickness of .25 inches (6.4 mm). The ZT-1000 fixture provides accurate shielding quality data up through 2 GHz with repeatable data to 4 GHz.



## ZT-1705A

The ZT-1705A fixture is designed in compliance with the SAE ARP-1705 Rev A standard. The maximum outer diameter for testing is 4.0 inches (101 mm) for a circular gasket or 3.4 inches (86mm) for a square gasket. The maximum height is .5 inches (12.7 mm). The frequency range is from 10 kHz to 1 GHz.

## ZT-1705B

The ZT-1705B fixture is designed in compliance with the SAE ARP-1705 Rev B standard. The maximum outer diameter of the circular gasket tested is .75 inches (19 mm) with a maximum height of .125 inches (3.2 mm). The frequency range is from 10 kHz to 10 GHz.

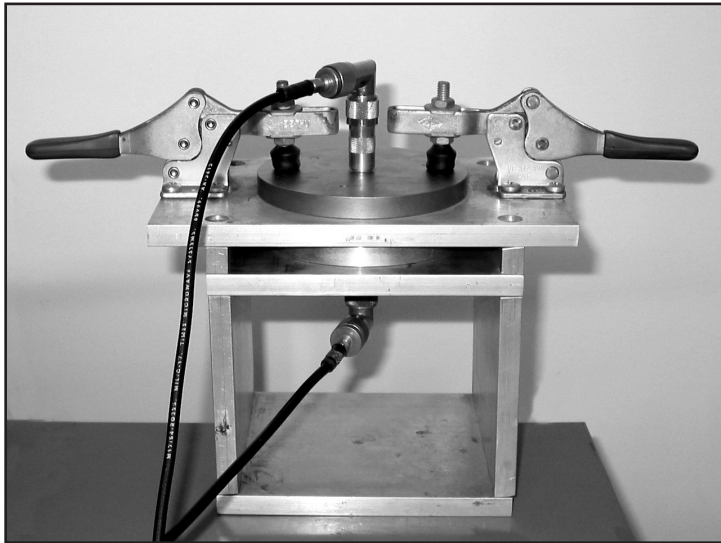

Typical  $Z_T$  Fixture

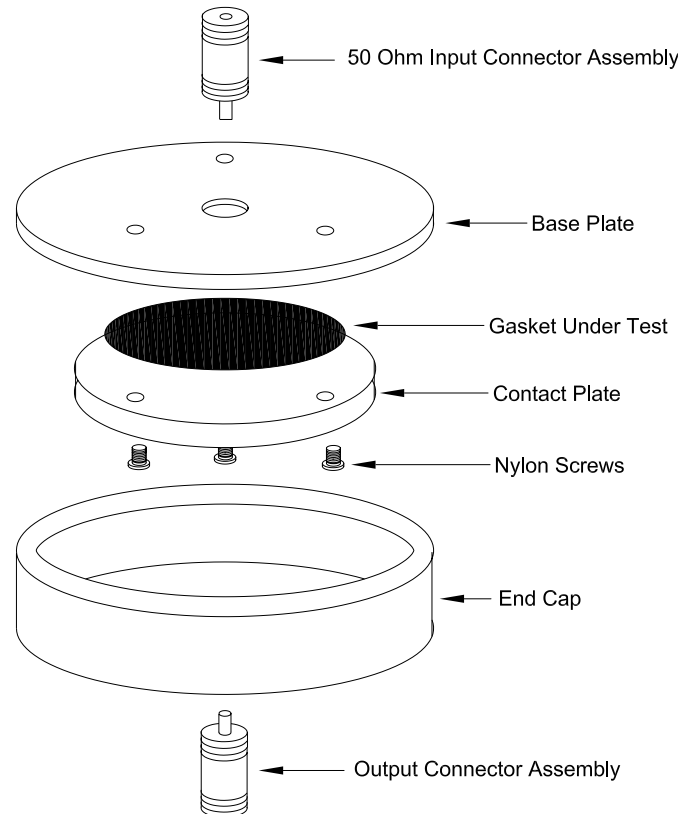

## Theory of Operation

The basic  $Z_T$  fixtures are comprised of the components illustrated. The signal enters the fixture through the 50 ohm input connector assembly and into the gasket retaining chamber. The chamber consists of the base plate, contact plate and gasket under test. The characteristic impedance of the chamber is controlled to be 50 ohms to the greatest extent possible, which results in a controlled current across the gasket.

The voltage across the gasket is measured by a receiver connected to the output connector assembly. The current path through the fixture from the gasket to the output connector results in a complex impedance. As long as the complex impedance is small compared to the 50 ohm impedance of the receiver, the measured voltage is approximately the same as the voltage across the gasket. As the impedance approaches 50 ohms, a correction factor must be applied to obtain an actual voltage across the gasket.

# Shielding Quality Test Results

The shielding quality of a gasket is as defined in SAE ARP-1705 Rev A and is the ratio of the impedance of the incident wave divided by the Transfer Impedance of the gasketed joint as follows:

$$SQ = 20 \log Z_W / Z_T$$

where  $Z_W$  = Impedance of the wave  
 $Z_T$  = Impedance of gasketed joint

This ratio is a good approximation of the shielding effectiveness of a gasketed joint when using the constraints and conditions consistent with electromagnetic theory and MIL-STD-285. Assuming a wave impedance of 377 ohms greatly simplifies the calculations.

i.e., shielding quality of a gasket having  $Z_T = 10^{-3} = 20 \log 377 / 10^{-3} = 111$  dB.

The chart above illustrates the shielding quality of gasketed joints assuming a plane wave (i.e., 377 ohms) as the incident field. As is illustrated, the shielding quality is greatly affected by the joint surface material finish. Oxidation and other aging phenomena can cause equal degradation to the shielding quality of the joint. This information is essential when selecting EMI gaskets and joint surfaces for use on electrical/electronic equipment requiring electromagnetic compliance.

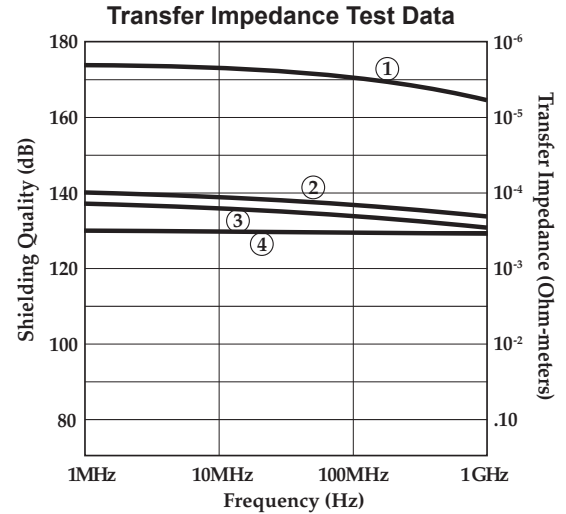

1. Tin Plated Spira-Shield Against **Tin** Plated Joint Surfaces
2. Tin Plated Spira-Shield Against **Zinc** Plated Joint Surfaces
3. Tin Plated Spira-Shield Against **Nickel** Plated Joint Surfaces
4. Tin Plated Spira-Shield Against **Aluminum** Joint Surfaces

*This data is representative of the test data we have obtained. Your results will vary depending on the applicable variables.*

## Required $Z_T$ Test Equipment

### Minimum System Requirements

- $Z_T$  Fixture. Consists of the contents shown on the previous page, and a stand used to house the fixture.
- Signal generator and receiver.
- Semi-rigid cables and compatible connectors.

### Recommended System Support

The following additional equipment is recommended to provide reliability and efficiency in obtaining shielding quality data.

- Spectrum analyzer (or network analyzer) with tracking generator. (Preamps and narrow bandwidth capability significantly improve the dynamic range of the test capability)
- Microwave switch network. (Provides a method of observing the output of the tracking generator without disconnecting the  $Z_T$  Fixture.) ZT-1000 and ZT-1705A fixtures only.
- Printer or Plotter
- Amplifier or Preamplifier

## Ordering Information

### The Basic System

- Z<sub>T</sub> Fixture with gold plated 6061-T6 aluminum base and contact plates
- Holding frame with clamps
- EMI gasket test procedure
- Gasket sample kit

Part Number	Maximum Sample Size	Sample Thickness	Maximum Frequency
ZT-1000	3.5" Outer Diameter - Circular	.25"	1 GHz
ZT-1705A	4" Outer Diameter - Circular 3.4" x 3.4" - Square	.5"	1 GHz
ZT-1705B	.75" Outer Diameter - Circular	.125"	10 GHz

### Additional Joint Surfaces

Each fixture comes with gold plated 6061-T6 aluminum joint surfaces for quality assurance testing purposes.

Gasketed joint testing (testing using other joint metals and plating) is used to test the shielding quality of gaskets using the joint materials and surface preparation under consideration.

Base and contact plates made from other base material with surface preparation (other than gold) can be provided upon request.

## Engineering Evaluation Testing

Spira has a complete transfer impedance test facility for performing engineering evaluation testing to your specifications and requirements. For further information, please contact us.

There are two ways of approaching the theory of shielding: the use of circuit theory, or the use of wave theory. The EMC industry uses a wave theory approach to shielding theory using abstract mathematical modeling techniques to yield a value of merit classified as “shielding effectiveness”. Shielding effectiveness is then used as a measurement to gauge the attenuation of the Electromagnetic (EM) fields through shielding barrier material.

The problem with the shielding equations consistent with the wave theory approach is assuming that both the source of the electromagnetic wave and the point of interest (after the wave leaves the barrier) are in the far field. If one or both of these are in the near field, the attenuation of the electric  $E$  fields, magnetic  $H$  fields, and power, can exceed 100 dB. The actual difference will vary as a function of variables associated with specific applications where the literature on the shielding of radiated EM fields does not address these conditions. The result is a significant confusion factor in the selection of shielding barrier material, facing design engineers who are required to meet EMC radiated emission and susceptibility requirements.

The circuit theory approach (included herein) employs mathematical modeling techniques consistent with college course work and yields a predicted field strength at any given distance from the shielding barrier material. The results can also be used to predict the shielding of a seam or gasketed joint in the barrier material (or enclosure). The circuit theory approach given below examines the wave as it penetrates a barrier and yields a value of the  $E$  and  $H$  fields as the wave exits the barrier.

## Introduction

A radiated electromagnetic (EM) wave is generated by the action of driving a current through a wire. An example is that of Figure 1 which represents a sending/receiver circuit on a PC card.

The wire (or PC card trace) acts as a transmitting antenna, as an emitter of EM interference and as a receptor with regard to EM susceptibility. A common method of reducing (or eliminating) the possibility of the PC trace being an emitter or receptor is by the use of a shielding barrier.

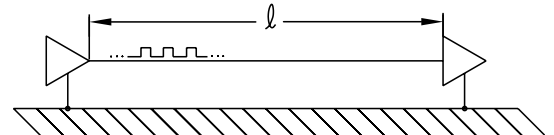

Figure 1

When an EM wave is impinged on a metallic (conductive) shielding barrier, currents are caused to flow in the barrier. As the wave penetrates the barrier, the current is attenuated (i.e., reduced in amplitude as illustrated in Figure 2) by a force called skin effect.

The power of the wave as it leaves the barrier is approximately equal to the current squared times the impedance of the barrier, and is in watts per meter squared.

As we learned above, currents flow in the shielding barrier as a function of the radiated wave being impinged on the barrier. When the current crosses a seam in the barrier (created by maintenance covers, etc.), a voltage is created across the seam, where the value of the voltage is equal to the current times the impedance of the seam. The seam then becomes a radiating antenna where the impedance and pattern is similar to that of a slot antenna. EMI gaskets are used to reduce the impedance of the seam and subsequent power radiating from the seam.

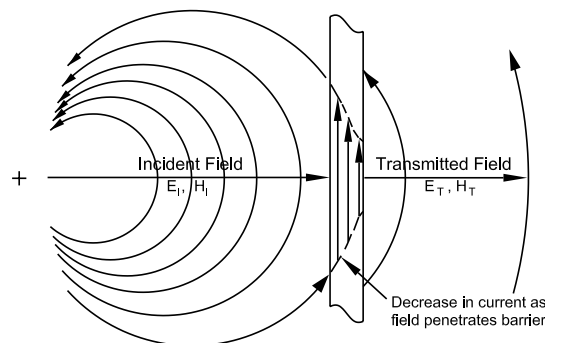

Figure 2

## Generation and Propagation of EM Wave

The undergraduate courses on EM theory introduced the concept of an EM wave by using Maxwell's derivation of displacement current. (i.e., driving a pair of parallel plates with an AC voltage source as illustrated in Figure 3.) The current that flows through the wire comes from the top plate and is stored in the bottom plate. The over-presence of the electrons on the bottom plate is illustrated by  $\ominus$  and the absence of electrons on the top plate is illustrated by  $\oplus$ . This creates an EM wave which is illustrated in Figure 4. The EM wave, consisting of the straight lines, is classified as a displacement current and is in Amperes per meter squared. The magnitude of the E field is equal to the voltage differential between the plates divided by the distance between the plates in meters. The resultant E field is in Volts per meter (e.g., a set of parallel plates is used to calibrate electric dipole antennas.)

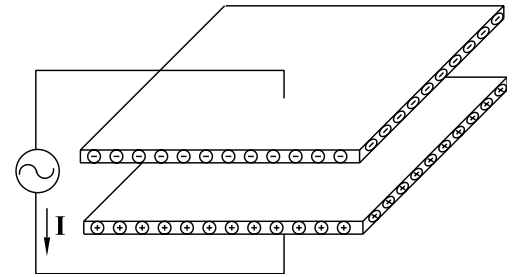

Figure 3

As is illustrated in Figure 4, the lines of flux in the center of the plates are straight and flow from the bottom to the top plate. At the edges they bow out, where the fields or lines of flux repel each other, forcing the bowing. The field that bows out represents a radiated EM wave. The radiated EM wave emanating from the trace of Figure 1 is similar to the radiated EM wave illustrated in Figure 4. The electric "E" field is tangent to the lines of flux (displacement current) as illustrated in Figure 4. The magnetic "H" field is a field perpendicular to the displacement current and points out of the paper (right hand rule).

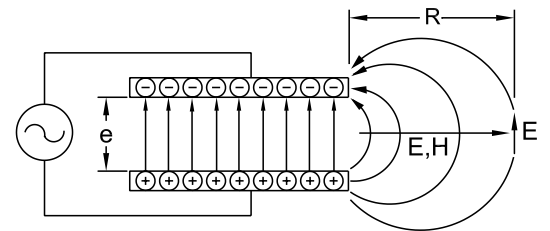

Figure 4

The set of plates as illustrated in Figure 4 produce a wave similar to that of the PC card trace of Figure 1 (and of an electric dipole antenna). If the transmitted power is known, the field strength can be calculated using the dipole antenna equation, i.e.,

$$P_R \approx 1.6P_T / 4\pi R^2$$

Where  $P_R =$  Field strength at distance  $R$  ( $W/m^2$ )

$P_T =$  Transmitted power ( $W/m^2$ )

$R =$  Distance from radiating source ( $m$ )

And power equation (poynting vector):

$$\bar{E} \times \bar{H} = P_R$$

$$E / H = 377\lambda / 2\pi R \quad R < \lambda / 2\pi \quad (\text{ohms})$$

$$= 377 \quad R \geq \lambda / 2\pi$$

$$\text{And } \lambda = 3 \times 10^8 / f \quad (m)$$

If the power is not known, the value of the electric field can be approximated using the following equation:

$$E \approx e / 2\pi R$$

$E =$  Electric field strength ( $V/m$ )

$e =$  Voltage across plates

$$H \approx 2\pi R E / 377\lambda \quad R < \lambda / 2\pi \quad (A/m)$$

$$= E / 377 \quad R \geq \lambda / 2\pi$$



## Suppression (Shielding) of EM Wave

When we place a shielding barrier in the path of the EM wave, the force of the wave causes current to flow in the barrier. As is illustrated in Figure 5, the excess electrons in the bottom plate create a force on the electrons in the barrier. This force causes the electrons to flow away from the point of contact. In a similar manner, the lack of electrons on the upper plate will create an excess of electrons on the barrier at the upper point of contact.

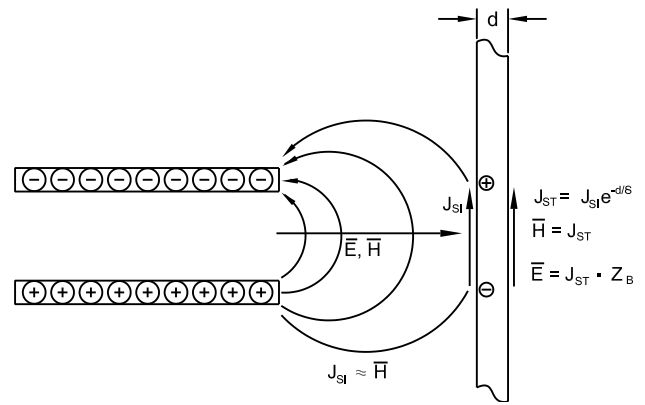

Figure 5

This current flow in the barrier is called the "surface current density" ( $J_S$ ) in amperes/meter, and is approximately equal to the H field incident on the barrier when the direction of the wave is perpendicular to the barrier. The current flowing in the barrier is attenuated by skin effect.

The current on the transmitted side is equal to  $J_{S1} e^{-d/\delta}$  (i.e., the current on the incident side attenuated by skin effect). The impedance of the wave emanating from the barrier is equal to the impedance of the barrier. The values of  $E_T$  and  $H_T$  are as illustrated in Figure 5 and are as follows:

$$H_T = J_{S1} e^{-d/\delta}$$

$$E_T = H_T Z_B$$

where  $E_T =$  Transmitted E field (V/m)

$H_T =$  Transmitted H field (A/m)

$d =$  Thickness of barrier (m)

$\delta =$  Skin depth (m)

$Z_B =$  impedance of barrier (ohms)

$\sigma =$  conductivity of barrier material (mhos/m)

$$Z_B = \frac{1+j}{\sigma\delta(1-e^{-d/\delta})}$$

## Field Strength Through Shield

From antenna theory we know that the power from an antenna is reduced as the square of the distance from its source. Shielding theory proposes that the wave as it passes through a barrier is attenuated but not changed with regard to direction. As such, the loss of power is a function of the distance from the original source of the wave as illustrated in Figure 6.

The power at a distance  $R_2$  from the barrier is equal to the following:

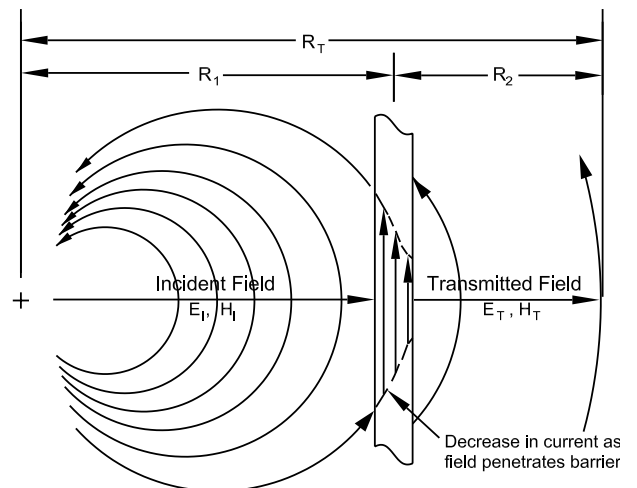

Figure 6

$$P_{R2} = P_T \left( \frac{R_1}{R_T} \right)^2$$

Where  $P_{R2}$  = Field strength at distance  $R_2$  ( $W/m^2$ )

$P_T$  = Transmitted power ( $W/m^2$ )

$$\approx E_T \cdot H_T \cos 45^\circ$$

$R_1$ ,  $R_2$ , and  $R_T$  are in meters

The impedance of the wave will vary from a low impedance (impedance of the barrier) to 377 ohms when the distance  $R_2 \geq \lambda/2\pi$ . The value of E and H can be closely approximated at a distance  $R_2$  when  $R_2 \geq \lambda/2\pi$  using the following equations:

$$E_{R2} \cdot H_{R2} = P_{R2} \quad (W/m^2)$$

$$\frac{E_{R2}}{H_{R2}} = 377 \text{ ohms}$$

When  $R_2 < \lambda/2\pi$  the value of E and H can be estimated using the following equations:

$$E_{R2} \cdot H_{R2} \approx P_{R2} \quad (W/m^2)$$

$$\frac{E_{R2}}{H_{R2}} \approx 2\pi R_2 (377) / \lambda \quad (\text{ohms})$$

$$\text{Where } \lambda = 3 \times 10^8 / f \quad (m)$$

## Gasketed Joint Shielding

When a radiated EM wave is impinged on a metallic shielding barrier, a current (surface current density in amps/meter) is generated in the material. When the current flows across a gasketed maintenance cover as illustrated in Figure 7, a voltage  $e$  is generated across the gasket. The value of  $e$  is equal to the current in amps/meter times the impedance of the joint (transfer impedance in ohm-meters).

The EM wave illustrated in Figure 7 is generated by the voltage across the gap and has the characteristics of a low impedance slot antenna.

The value of the radiated EM fields can be estimated from the example of Figure 7 as follows:

$$E_T \approx 2e / 2\pi R = J_S Z_T / \pi R \quad (V/m)$$

$$H \approx E_T \lambda / 2\pi R (377) \quad R < \lambda / 2\pi \quad (A/m)$$

$$H_T = E_T / 377 \quad R \geq \lambda / 2\pi$$

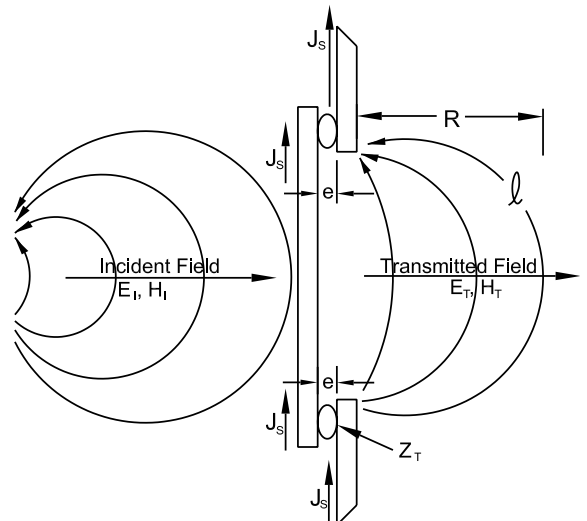

Figure 7

$J_S$  = Current due to Field Striking Barrier

$e$  = Voltage Across Gasket  
=  $J_S Z_T$

$Z_T$  = Transfer Impedance of Gasketed Joint (ohm-m)

# Shielding Quality Data of Spira Gaskets

## Why We Use Transfer Impedance Testing

There are two industry-accepted methods for testing the shielding capability of EMI gaskets. These are: (1) Shielding Effectiveness (as defined in MIL-DTL-83528), and (2) Transfer Impedance as defined in SAE ARP-1705.

The Shielding Effectiveness test was designed by one of the EMI gasket manufacturers where there exists built in test anomalies, which provide extremely high levels of shielding for the products under test. As an example, tests performed at 2 GHz illustrated "Shielding Effectiveness" test results in excess of 120 dB using no gasket between the enclosure and cover specified in the test procedure. Placing a sheet of non-conductive newspaper as a gasket between the cover and shielded enclosure provided 93 dB of shielding.

"Transfer Impedance" as a method of testing EMI gasket was derived from the academic community. Transfer Impedance measures the impedance of a gasket and gasketed joint. The procedure for measuring transfer impedance of gaskets (or gasketed joints) is detailed in SAE, ARP-1705 Rev A dated January 1, 2006.

The test data that follows has been done using Spira's ZT-1000 Transfer Impedance Test Fixture, a spectrum analyzer, and a printer.

## Shielding Quality

Shielding quality as defined in SAE, ARP-1705 Rev A is the theoretical "Shielding Effectiveness" of the gasket and gasketed joint using the conditions and constraints of shielding theory and MIL-STD-285. The definition as listed in ARP-1705 Rev A is illustrated below. The shielding quality data illustrated in the pages that follow assume that the incident wave is a plane wave having an impedance of 377 ohms.

$$\text{Shielding Quality (SQ)} = 20 \log Z_w / Z_T$$

$$\begin{aligned} \text{where } Z_w &= 377 \lambda / 2\pi R \quad R < \lambda / 2\pi \\ &= 377 \quad R \geq \lambda / 2\pi \end{aligned}$$

$$\lambda = c / f$$

$$c = 3 \times 10^8 \text{ meters/sec} \\ \text{(speed of light)}$$

$$f = \text{frequency (Hertz)}$$

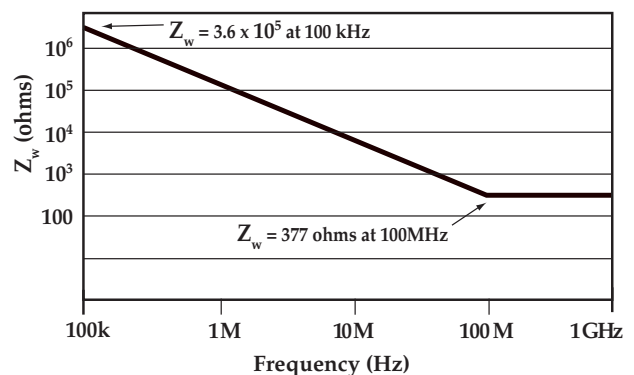

*Z<sub>w</sub> using constraints consistent with MIL-STD-285*

## Joint Surfaces Are Important

In the data shown on the following pages we have illustrated the transfer impedance (and subsequent Shielding Quality) of the gaskets against two surfaces: tin plated aluminum and 6061-T6 aluminum. This is presented to illustrate the importance of selecting a gasket that will provide the required shielding using the specific joint surfaces of concern.

To access the shielding quality for our gaskets using applicable joint surfaces please visit our website: [www.spira-emi.com/quality](http://www.spira-emi.com/quality).

## Test Conditions

All test data consists of new gaskets and freshly cleaned joint surfaces in a controlled temperature, low humidity office environment. Aging and/or environmental conditions may deteriorate the level of shielding provided by a gasket in conjunction with specific joint surfaces.

## Shielding Quality of Spira-Shield Gaskets

This data applies to *Spira-Shield* tin plated beryllium copper gaskets, or other gaskets which include it, such as the following standard configurations:

- Spira-Strip
- “D” Multi-Seal
- Basic Multi-Seal
- EMI & Environmental Connector-Seal  
(see graph, line 1)

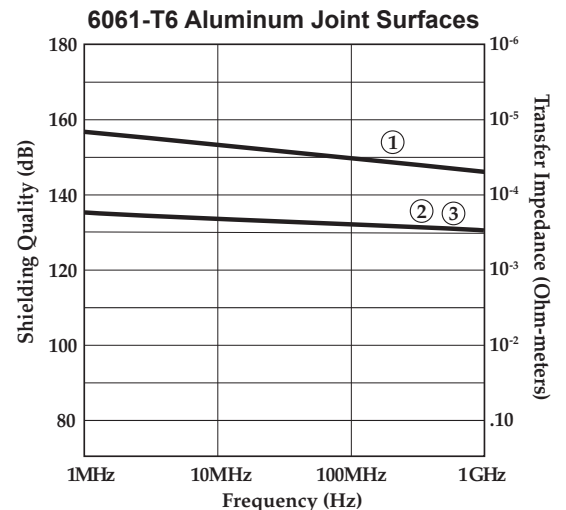
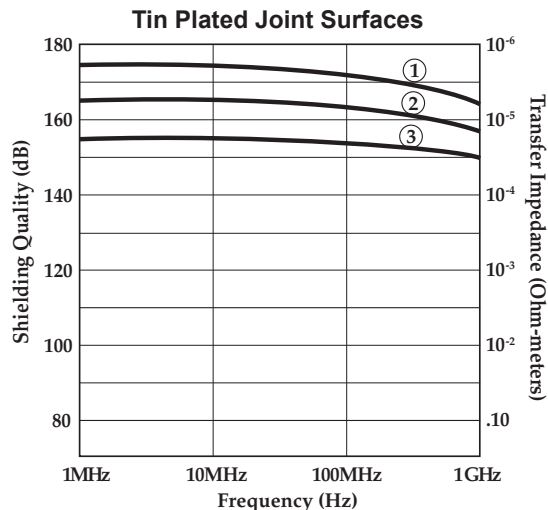

This data is representative of the test data we have obtained. Your results will vary depending on the applicable variables.

1. Standard Force Spira-Shield, Tin Plated Beryllium Copper Gasket, Example: SS-04, IWSS-04
2. Moderate Force Spira-Shield, Tin Plated Beryllium Copper Gasket, Example: MS-04, IWMS-04
3. Low Force Spira-Shield, Tin Plated Beryllium Copper Gasket, Example: LS-04, IWLS-04

# Shielding Quality of Quick-Shield Gaskets

This data applies to *Quick-Shield* stainless steel gaskets, or other gaskets which include it, such as Quick-Strip.

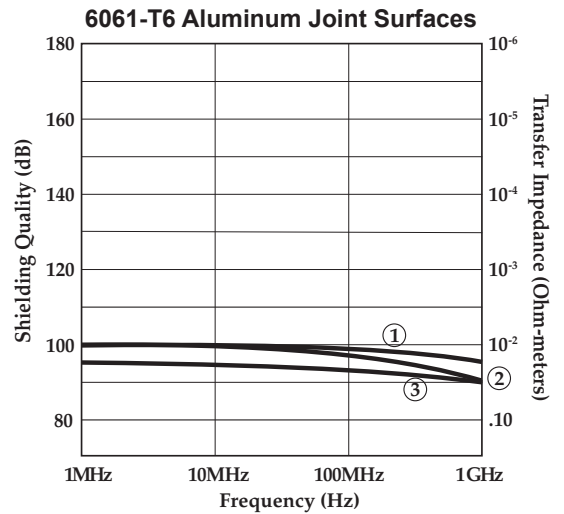
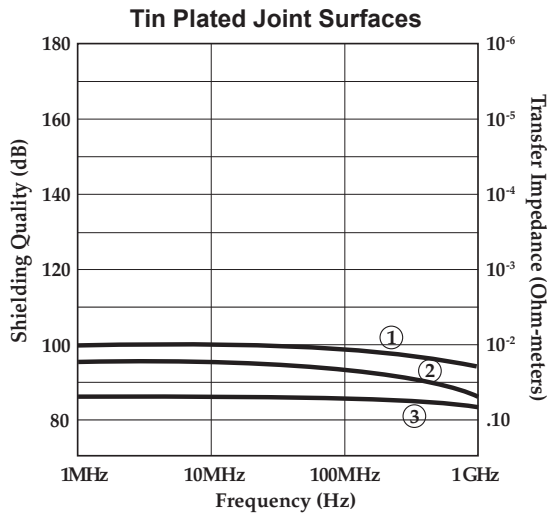

This data is representative of the test data we have obtained. Your results will vary depending on the applicable variables.

1. Standard Force Quick-Shield, Stainless Steel Gasket, Example: NI-04
2. Moderate Force Quick-Shield, Stainless Steel Gasket, Example: NM-04
3. Low Force Quick-Shield, Stainless Steel Gasket, Example: NL-04

# Shielding Quality of Ultra Quick-Shield Gaskets

This data applies to *Ultra Quick-Shield* tin plated stainless steel gaskets, or other gaskets which include it, such as Quick-Strip with Ultra Quick-Shield.

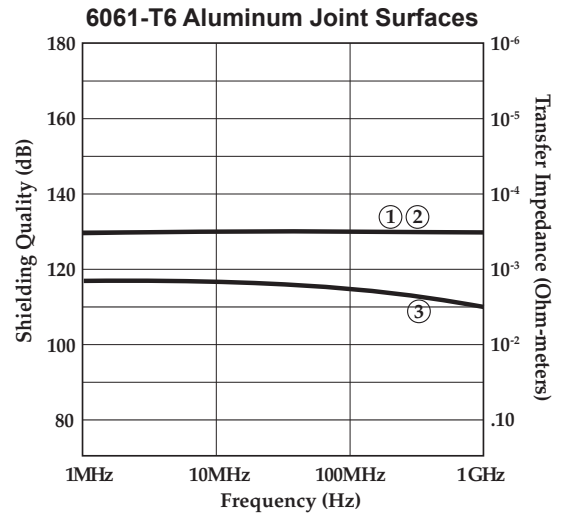
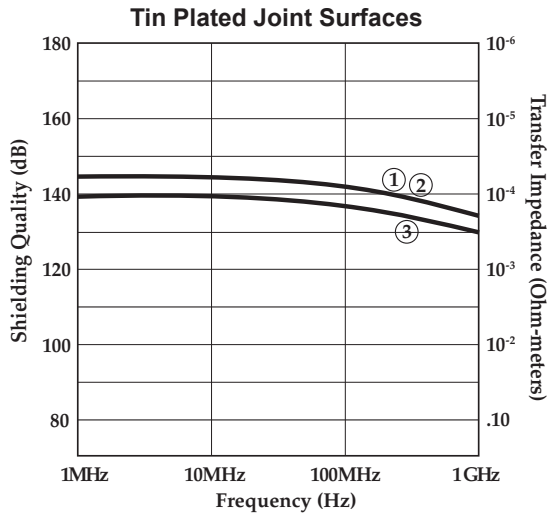

This data is representative of the test data we have obtained. Your results will vary depending on the applicable variables.

1. Standard Force Ultra Quick-Shield, Tin Plated Stainless Steel Gasket, Example: TNI-04, IWNI-04
2. Moderate Force Ultra Quick-Shield, Tin Plated Stainless Steel Gasket, Example: TNM-04, IWNM-04
3. Low Force Ultra Quick-Shield, Tin Plated Stainless Steel Gasket, Example: TNL-04, IWLS-04



# Shielding Quality of Flexi-Shield Gaskets

This data applies to *Flexi-Shield* or other gaskets which include it, such as Flexi-Shield O-Rings (see graph, line 1).

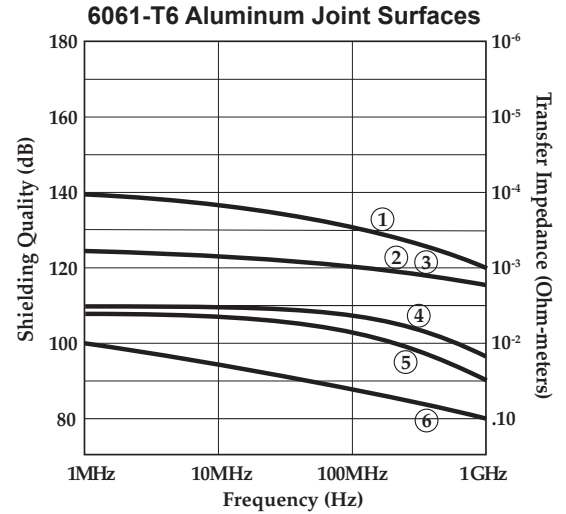
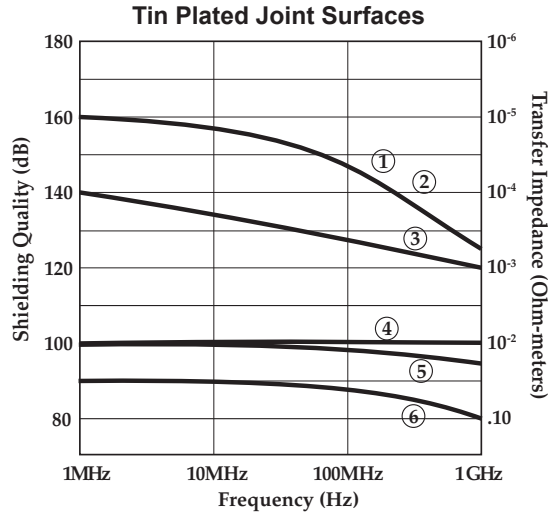

This data is representative of the test data we have obtained. Your results will vary depending on the applicable variables.

1. Standard Force Flexi-Shield, Tin Plated Beryllium Copper Gasket, Example: ST-06, IWST-06
2. Moderate Force Flexi-Shield, Tin Plated Beryllium Copper Gasket, Example: MT-06, IWMT-06
3. Low Force Flexi-Shield, Tin Plated Beryllium Copper Gasket, Example: LT-06, IWLT-06
4. Standard Force Flexi-Shield, Stainless Steel Gasket, Example: SQ-06
5. Moderate Force Flexi-Shield, Stainless Steel Gasket, Example: MQ-06
6. Low Force Flexi-Shield, Stainless Steel Gasket, Example: LQ-06

# Shielding Quality of Enduro-Shield Gaskets

This data applies to *Enduro-Shield* or other gaskets which include it, such as the following standard configurations:

- Enduro-Shield O-Rings (see graph, line 1)
- EMI Connector-Seal, SSCG series (see graph, line 2)

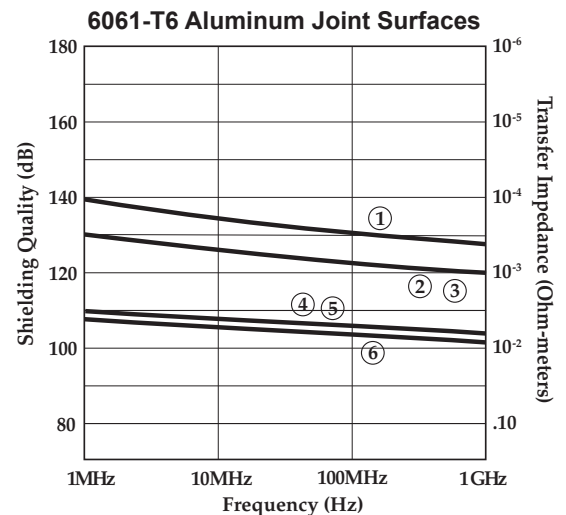
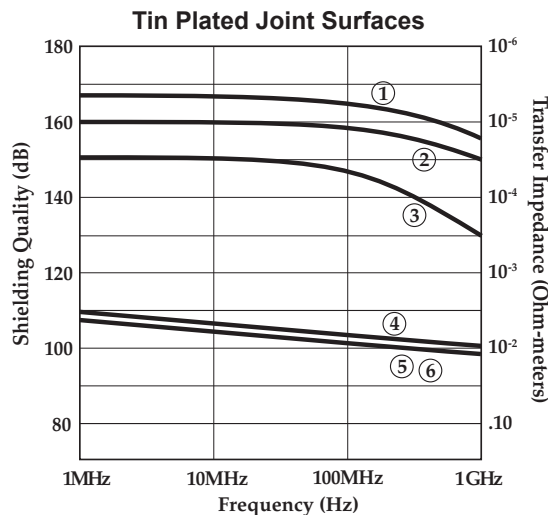

This data is representative of the test data we have obtained. Your results will vary depending on the applicable variables.

1. Standard Force Enduro-Shield, Tin Plated Beryllium Copper Gasket, Example: SISS-04, IWSISS-04
2. Moderate Force Enduro-Shield, Tin Plated Beryllium Copper Gasket, Example: SIMS-04, IWSIMS-04
3. Low Force Enduro-Shield, Tin Plated Beryllium Copper Gasket, Example: SILS-04, IWSILS-04
4. Standard Force Enduro-Shield, Stainless Steel Gasket, Example: SINI-04
5. Moderate Force Enduro-Shield, Stainless Steel Gasket, Example: SINM-04
6. Low Force Enduro-Shield, Stainless Steel Gasket, Example: SINL-04

# Groove Mounting Techniques

Spira Gaskets are made from spring temper tin plated beryllium copper or stainless steel. The advantage of using these materials is that the gasket acts as a spring and the ratio of force to deflection is linear. So if it takes one pound to deflect the gasket 1% of its diameter, it will take 25 pounds to deflect the gasket 25% of its diameter, provided that the sides of the gasket are not constrained during compression. This advantage allows fastener spacing to be calculated to fairly close tolerances. During deflection, to avoid damaging the gasket as well as to take advantage of linearity, it is important that the sides of the gasket not be constrained. To achieve this, all but one of the following groove designs allows lateral freedom of movement for the gasket. Optimal deflection is 25% of the gasket's diameter which minimizes compression set.

With proper design, significant savings can be realized in the reduction of fasteners and fastener maintenance costs. These savings can in turn more than pay for the cost of the gasket as well as improving performance and reliability over the life of the system. See page 56 for information on how to calculate fastener spacing.

## Application Information

The following types of gaskets can be groove mounted:

- Spira-Shield
- Flexi-Shield
- Enduro-Shield
- Quick-Shield
- Ultra Quick-Shield
- "D" Multi-Seal

## Standard O-Ring Groove

See page 54 for recommended groove dimensions.

The width of the groove should be a minimum of 35% larger than the diameter of the gasket. The depth of the groove should be 75% the diameter of the gasket.

### Advantages

- Encourages the shielding performance illustrated in the Shielding Quality data sheets.
- Low manufacturing/maintenance costs.

### Disadvantages

- Spiral can fall out during manufacturing and maintenance.

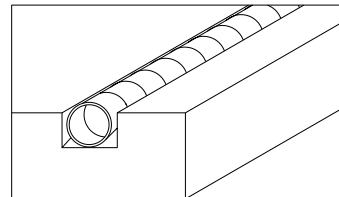

Uncompressed gasket in o-ring groove.

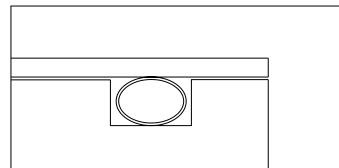

Compressed gasket in o-ring groove.

## Groove Corners

See page 54 for recommended groove dimensions.

If using a groove in a square configuration, it is important to choose a groove radius that will not damage the spiral, nor inhibit its performance. Generally speaking, we recommend an optimal corner radius of 1.5 times the diameter of the gasket or greater. The recommended radius for the "D" Multi-Seal is 1.5 times the width (E dimension) of the gasket.

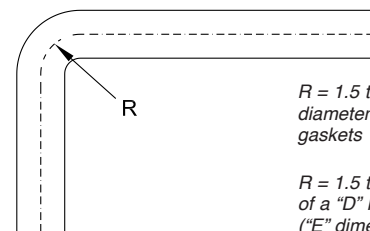

$R = 1.5$  times the diameter of spiral gaskets

$R = 1.5$  times the width of a "D" Multi-Seal gasket ("E" dimension)

## Dovetailed O-Ring Groove

See page 54 for recommended groove dimensions.

This groove can either be extruded, or machined using a special dovetail cutter which is available from Spira. When machining this groove, a standard o-ring groove must be machined first. See the Dovetail Groove Cutter data sheet for more information (page 36).

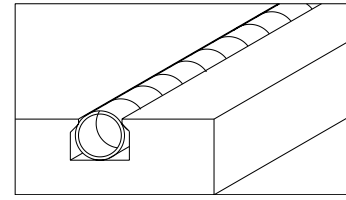

Uncompressed gasket in dovetailed groove.

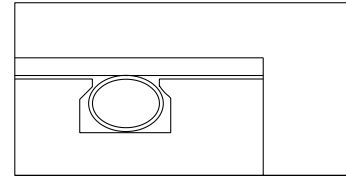

Gasket in dovetailed groove compressed by cover.

### Advantages

- Encourages the shielding performance illustrated in the Shielding Quality data sheets.
- Holds spiral in place.
- Ease of maintenance.
- Facilitates easy field installation.
- Can be incorporated into an extrusion at no extra cost.

### Disadvantages

- Approximately 30% higher manufacturing cost than standard o-ring groove.
- Deburring of the top opening can widen the opening to a point where the spiral may fall out. We recommend that deburring be performed using Scotch Brite or fine sandpaper. **DO NOT** use a deburring tool.

## O-Ring Groove with Adhesive

Use the same groove dimensions as the standard o-ring groove discussed previously. Use very small ( $1/16$ " ) dots of glue every 3-4" along the groove. Since the glue may degrade the shielding, use as little as possible to hold the gasket in place. You can also minimize shielding degradation by placing the glue dots at fastener locations. We recommend using either super glue, epoxy, or RTV. We *do not* recommend the use of conductive adhesives since their conductivity tends to degrade over time, thus degrading the shielding and giving you a false indication of the long-term shielding you will achieve.

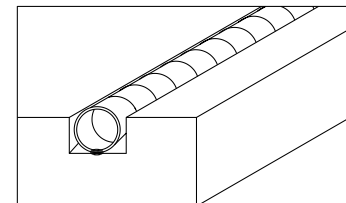

Uncompressed gasket in o-ring groove held in place by a dot of adhesive.

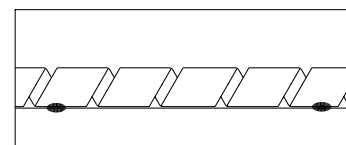

Small dots of adhesive every 3-4 inches holds gasket in place.

### Advantages

- Low manufacturing and maintenance costs.
- Holds Spiral in place.

### Disadvantages

- Slightly reduced shielding if adhesive is not placed at the fastener location.
- Shielding can be severely reduced if too much adhesive is applied.
- Labor costs to apply adhesive.

## O-Ring Groove with Pinch Bosses

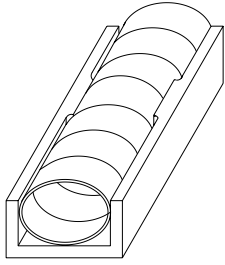

Gasket held in place by pinch boss o-ring groove.

This is a standard o-ring groove with narrower sections every 2 to 4 inches that “pinch” the spiral in place. Since this groove can be die-cast or molded into an enclosure, it is ideal for use in high-volume cost-sensitive applications.

The figure illustrates suggested dimensions according to the diameter (D) of the gasket. The undercut directly under the pinched area is critical in the design and use of the groove. Contact us for any additional information.

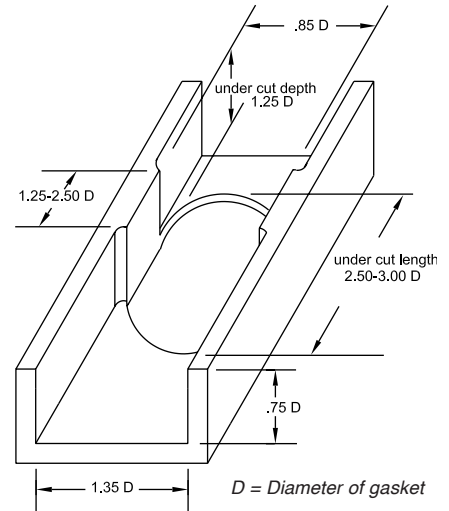

### Advantages

- Very cost effective for high volume molded or die cast applications.
- Can effectively be used to eliminate cross-talk on printed circuit boards.

### Disadvantages

- Slightly reduced shielding.

## Narrow O-Ring Groove

This groove is only recommended in retrofit situations where the cost or time involved with changing to a more suitable groove is prohibitive. The width of the groove is the same diameter as the gasket. The depth of the groove should be roughly 75% of the diameter of the gasket. The gaskets recommended for the narrow o-ring groove are our “moderate force” gaskets or low force Flexi-Shield.

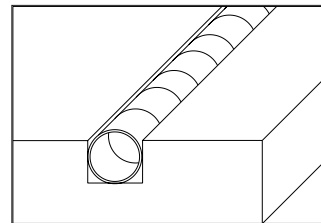

Uncompressed gasket in o-ring groove of same diameter as gasket.

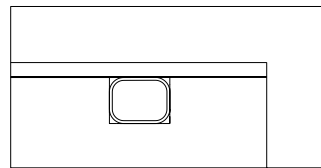

Gasket compressed in o-ring groove of same diameter as gasket. Note that gasket will be misshapen when removed.

### Advantages

- Good for retrofit situations where a groove already exists.
- Encourages highest possible shielding for the gasket in use.
- Spiral is not likely to fall out of the groove.

### Disadvantages

- Force required to compress gasket is significantly greater. This will increase the number of fasteners required, which in turn increases materials and maintainability costs.
- The force-to-deflection ratio is non-linear, which complicates calculations for fastener placement.
- When the gasket is compressed it will be deformed, so if the gasket is ever removed from the groove it must be replaced.

## Groove Mounting Other Gaskets

Traditionally, only our spiral type gaskets are recommended for groove mounting. However, almost any type of gasket can be designed into a groove if desired. The important thing to remember is to allow 25% of the diameter of the spiral to protrude above the top of the groove. Also, be sure to choose a groove wide enough to allow the spiral lateral expansion for optimal performance.

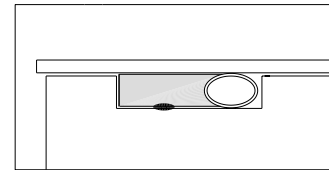

Spira-Strip mounted in a groove and held in place by adhesive.

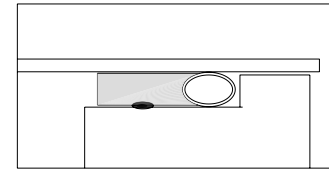

Spira-Strip mounted in a groove cut into edge of equipment chassis. A bead of adhesive (on the elastomer only!) holds it in place.

## Groove Dimensions

The table below shows the recommended mounting dimensions for commonly used sizes of spiral gaskets. The chart applies to Spira-Shield, Ultra Quick-Shield, Quick-Shield, Flexi-Shield, Enduro-Shield, and "D" Multi-Seal gaskets. The dash numbers shown can be matched with those in the part number charts of the applicable gasket. We have not included dimensions for the narrow o-ring groove. Generally speaking, a narrow groove is defined as any groove that is narrower than the recommended width of our other o-ring grooves.

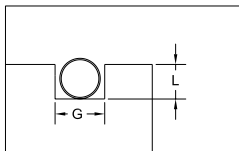

Quick-Shield in an o-ring groove.

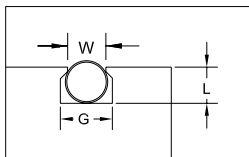

Spira-Shield in a dovetailed o-ring groove.

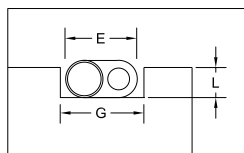

"D" Multi-Seal gasket in an o-ring groove.

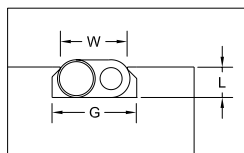

"D" Multi-Seal gasket in a dovetailed o-ring groove.

Spiral Dash Number	Spiral Diameter ("D")	Recommended Mounting Dimensions		
		Depth L +.002" - .000" (.75D*)	Width G +.007" - .005" (1.35D*)	Width W +.000" - .002"
-02	.034"	.023"	.046"	.033"
-03	.047"	.035"	.063"	.045"
-04	.063"	.046"	.094"	.060"
-.070	.070"	.053"	.094"	.067"
-05	.078"	.059"	.109"	.075"
-06	.094"	.070"	.125"	.090"
-.103	.103"	.077"	.141"	.099"
-07	.109"	.082"	.156"	.105"
-08	.125"	.094"	.171"	.121"
-.139	.139"	.104"	.187"	.134"
-09	.141"	.105"	.187"	.136"
-11	.172"	.128"	.234"	.165"
-12	.187"	.140"	.250"	.181"
-16	.250"	.185"	.343"	.240"
-20	.312"	.234"	.422"	.300"
-24	.375"	.280"	.500"	.364"
-32	.500"	.375"	.667"	.485"
"D" Multi-Seal Dash Number	"D" Multi-Seal Width ("E")	Depth L (.75E)	Width G (1.35E**)	Width W
-0421	.141"	.046"	.187"	.138"
-0632	.188"	.070"	.250"	.180"
-0842	.250"	.094"	.300"	.240"
-1263	.375"	.140"	.500"	.367"
-1684	.500"	.185"	.625"	.485"

\* D = Diameter of Spiral

\*\* E = Width of "D" Multi-Seal



## Application Information

### Surface Preparation

- Minimal surface preparation is required with Spira EMI gaskets. A clean surface will encourage the highest level of shielding attainable.
- For environmental sealing a 32 micron finish is recommended.

### Adhesion

- We recommend you *do not* use conductive sealants with Spira EMI gaskets. Our shielding is achieved through the metal-to-metal contact between the spiral and joint surfaces. Conductive sealants will merely get in the way of this.
- To apply gaskets that do not have adhesive backing, you can use either super glue, epoxy or RTV. Be careful to apply the adhesive only to the rubber portion of the gasket. Do not get glue on the spiral as it will degrade the shielding.

## Fastener Placement

Fasteners may be placed on either side of the gasket. Care should be taken to avoid puncturing the spiral. To maintain the integrity of the EMI bond it is important that each fastener is referenced to the chassis by making good metal-to-metal contact.

When using the gasket to achieve an environmental seal, care must be taken to ensure that the fastener placement does not compromise this seal.

### Excellent Design

Screw makes EMI bond with chassis. Screw going through rubber elastomer maintains the integrity of the environmental seal.

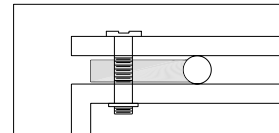

*Excellent Design:*  
Gasket held in place with screw and nutplate.

### Good Design

The risk of moisture leak is minimized by the use of a rubber washer. The metal nutplate ensures that the screw will be referenced to the chassis to maintain the integrity of the EMI seal.

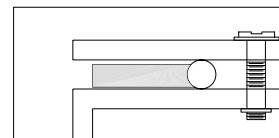

*Good Design:*  
Gasket held in place with screw, nutplate and one rubber washer.

### Poor Design

Moisture can leak through the screw hole, compromising the environmental seal.

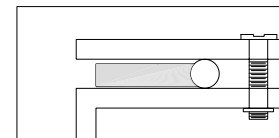

*Poor Design:*  
Gasket held in place with screw and nutplate.

### Poor Design

The use of two rubber washers insulates against environmental leakage, but also prevents the screw from being referenced to the chassis. This creates an EMI "hole" and can significantly degrade the shielding quality of the joint.

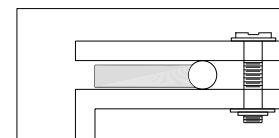

*Poor Design:*  
Gasket held in place with screw, nutplate and two rubber washers.

# How To Calculate Fastener Spacing

One of the great advantages of our spiral design is that the ratio of force to deflection is linear. That is, if it takes one pound to deflect the gasket 1% of its diameter, it will take 25 pounds to deflect the gasket 25% of its diameter. This allows fastener spacing to be easily calculated to fairly close tolerances.

If you've already chosen a gasket, these formulas can be used to determine fastener type and spacing in your application. However, if you're not sure whether to employ a standard, moderate or low force gasket, these formulas can give you information that may help you determine which gasket will be the most cost effective. Please visit [www.spira-emi.com/spacing.htm](http://www.spira-emi.com/spacing.htm) for an automatic spacing calculator.

## Application Information

Formula 1 (below) can be used to calculate fastener spacing for all our gaskets, with the special considerations shown for certain types of gaskets. This formula determines fastener spacing along a straight edge. Corners require tighter spacing because of the increased stress placed on the cover at those points.

### Fasteners

In this context, fasteners, include screws and any other means of attachment that will exert enough force to compress the gaskets 25% of their diameter. Care must be exercised to ensure this is true. The force each fastener must exert is equal to  $F_0$  as shown in Formula 2 (below).

## Calculating Fastener Spacing

### The Formulas

The formulas shown here are derived directly from classical beam problems using ideal theoretical values.

$$(1) \quad L = \left[ \frac{480YE t^3 d}{13F_1 + 2F_2} \right]^{1/4} \times 80\% \quad (2) \quad F_0 = \frac{(2F_1 + F_2) L}{3}$$

**Note:** We multiply by 80% as a safety factor.

### Variables

All dimensions are in inches unless otherwise noted.

- L = length between fasteners
- Y = width of cover edge  
(Assume 1" if not distinct)
- E = modulus of elasticity of cover plate  
=  $10^7$  psi for aluminum  
=  $3 \times 10^7$  psi for steel
- t = thickness of cover edge
- d =  $\Delta$  deflection of gasket  
= .022" for Spira Cell  
= .20D" for all other gaskets
- D = diameter of spiral
- $F_1$  = minimum force of gasket on cover  
(pounds/inch)
- $F_2$  = maximum force of gasket on cover  
(pounds/inch)
- $F_0$  = force fastener must exert to compress  
gasket 25% of its diameter.

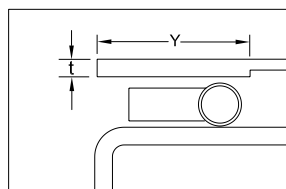

Both the "Y" and "t" are distinct in the top two illustrations.

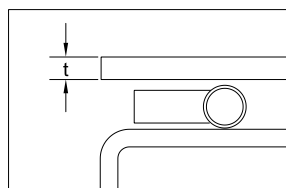
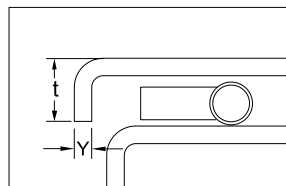

Since "Y" is not distinct, we assume it to be 1".



**SS-04:** Use three fasteners on each side for a total of 12 fasteners.

**MS-04:** Use three fasteners on the 12" side and two fasteners on the 10" side for a total of 10 fasteners.

**LS-04:** Use two fasteners on the 12" side and two fasteners on the 10" side for a total of 8 fasteners.

### Design Analysis

**SS-04:** Acceptably wide spacing but requires a 70 pound fastener load which makes the use of quarter turn fasteners impossible.

**MS-04:** Acceptably wide spacing but requires a 32 pound fastener load and the maximum load our quarter turn fastener can supply is 25 pounds. However, we can take Equation 2 and work backwards using our knowledge of the maximum load of a quarter turn fastener. So, we take the  $F_0$  equation, set it equal to 25 pounds and solve for "L".

$$25 = \frac{14L}{3} \quad L = 5.4''$$

With this additional constraint, the fastener spacing is reduced to 5.4" which will require using 3 fasteners on each side for a total of 12 fasteners but will allow us to use quarter turn fasteners.

**LS-04:** Acceptably wide spacing and requires only a 10 pound fastener load which can be easily achieved using quarter turn fasteners.

### Solution

Either the MS-04 with 12 fasteners or the LS-04 with 8 fasteners will work well with quarter turn fasteners. At this point, our decision must be based on cost versus convenience factors. The MS-04 gasket is more durable, slightly lower in price and will yield slightly higher shielding. The final determination is based on answering the question of whether the cost of four additional fasteners, in terms of time and dollars, is worth the benefits of using the MS-04 gasket.

## Example#2

### Application

Assume we need to shield an aluminum box, and we have decided to use a groove mounted "MS" series Spira-Shield gasket with 6.0 inch fastener spacing. What is the minimum size standard gasket we can use?

### Variables

Material: Aluminum	$E = 10^7$ psi
Cover thickness = .125"	$t = .125''$
Fastener Spacing = 6.0"	$L = 6.0$
Width of cover edge is unknown	Assume $Y = 1''$

### Formulas

$$d = .20D = \frac{(1.25L)^4 (13F_1 + 2F_2)}{480YE t^3}$$

### Calculations

$$d = \frac{(3.16 \times 10^3)(46)}{9.38 \times 10^6} = .0155$$

$$D = .0155 / .20 = .0775$$

### Solution

The MS-05 Spira-Shield gasket has a diameter of .078". Therefore, the minimum size Spira-Shield gasket which can be used is an MS-05.

# Material Specifications

Spira's EMI/RFI products are made using the finest materials and processes in compliance with AS9100 and ISO 9001. Material certifications are available upon request when your order is placed. Materials used are typically purchased to the following specifications unless otherwise noted or requested.

Material	Component / Process	Specification	Storage Temp	Operating Temp
Spiral	Beryllium Copper	ASTM-B-194	Ambient	-73 to 232° C, -100 to 450° F
	Stainless Steel	AMS-5906	Ambient	< 704° C, < 1300° F
Plating	Chemical Film	MIL-DTL-5541 Class 3	Ambient	< 66° C, < 150° F
	Chemical Film (RoHS)	MIL-DTL-5541 Class 3, Color Clear	Ambient	< 66° C, < 150° F
	Gold	MIL-DTL-45204, Type II, Grade C, Class 1	Ambient	< 274° C, < 525° F
	Pure Tin (RoHS)	ASTM-B-545	Ambient	< 150° C, < 302° F
	Tin-Lead	90% Tin, 10% Lead per AMS-P-81728	Ambient	< 150° C, < 302° F
	Sulfamate Nickel	AMS-QQ-N-290B, Class 2	Ambient	< 649° C, < 1200° F
Rubber	EPDM (Solid)	ASTM D2000 M3 BA	Ambient	-80 to 275° C, -112 to 527° F
	Fluorosilicone (Solid)	Blue per AMS-R-25988, Type II, Class I, Grade 40	Ambient	-62 to 204° C, -80 to 400° F
	Fluorosilicone (Sponge)	AMS-3323	Ambient	-62 to 204° C, -80 to 400° F
	Neoprene (Sponge)	ASTM-D-6576, Type II, Grade A, Condition-Medium	Ambient	-54 to 121° C, -65 to 250° F
	PVC Cord	Commercial Grade	Ambient	-30 to 160° C, -22 to 320° F
	Silicone (Solid)	A-A-59588, Class 2B, Grade 40 or 60 See product spec sheet for grade.	Ambient	-38 to 204° C, -100 to 400° F
	Silicone (Sponge)	Red per ASTM-D-6576, Type II, Grade C, Condition-Medium	Ambient	-38 to 204° C, -100 to 400° F
	Thermal Plastic Rubber	ASTM-D-2000 CA710, C32, EA14, F19	Ambient	-80 to 275° C, -112 to 527° F
Adhesive	Epoxy	2216 B/A per ASTM-D-2000	Ambient	-80 to 275° C, -112 to 527° F
	Fluorosilicone (Enduro-Shield core)	Dow Corning 730 RTV	≤ 32° C	-57 to 260° C, -71 to 500° F
	Fluorosilicone (Red)	Dow Corning Q4-2817 Sealant	≤ 32° C	-57 to 260° C, -71 to 500° F
	Neoprene (Contact Cement)	MMM-A-1617, TYPE II	-16° to 27° C	-67 to 177° C, -89 to 351° F
	PSA (Neoprene)	Rubber/Acrylic adhesive	Ambient	-34 to 65° C, -30 to 150° F
	PSA (Silicone & Fluorosilicone)	Acrylic Adhesive	24° C	-40 to 121° C, -40 to 250° F
	Silicone (Enduro-Shield standard core)	Dow Corning 732 RTV Per MIL-A-46106, Group I, Type I	≤ 32° C	-60 to 177° C, -76 to 351° F
	Silicone (Enduro-Shield Stainless Steel gaskets)	Dow Corning 737	≤ 32° C	-65 to 177° C, -85 to 351° F
	Silicone (Non-acetic acid base)	Dow Corning 3145 RTV Per MIL-A-46146, Group II, Type I	≤ 32° C	-50 to 200° C, -58 to 392° F
	Silicone (White, non-outgassing)	Dow Corning 61125	≤ 32° C	-60 to 177° C, -76 to 351° F
Other	Connector-Seal	6061-T6 Aluminum per AMS-4027 (SSCG)	Ambient	< 343° C, < 650° F
	Metal Frame/Core	Stainless Steel per AMS-5516M (Core)	Ambient	< 704° C, < 1300° F
	Dovetail Groove Cutter	Tungsten Carbide	Ambient	N/A
	AirVent Filter Extrusion	6061-T4 Aluminum per AMS-QQ-A-200/8	Ambient	< 343° C, < 650° F
	Fan Filter Frame	6061-T4 Aluminum per AMS-4026	Ambient	< 343° C, < 650° F
	Honeycomb Panel	Aluminum per AMS-C-7438	Ambient	< 204° C, < 400° F
		Brass per ASTM-B-36/B 36M Foil soldered together per ASTM-B-32	Ambient	< 230° C, < 446° F
Threaded Insert	Cadmium plated Alum. AMS-QQ-P-416	Ambient	N/A	



# Material Compatibility

The shielding effectiveness of EMI gasketed joints can be significantly affected by corrosion. The corrosion of concern is a galvanic cell between the gasket and the joint surface in the presence of moisture or salt-fog atmospheres. The chart below lists six common materials used in EMI gaskets along with their degree of compatibility with common joint surface material/plating combinations. (The chart was extracted from ARP-1481, published by the Society of Automotive Engineers). The legend describes the degree of compatibility and/or requirements for obtaining a corrosion free joint. The term “requires sealing” means that the gasketed joint surfaces must be protected in some way from the moisture and/or salt-fog atmospheres.

Gasket Materials	Joint Surface Materials																																								
	Aluminum Clad 1000, 3000, 5000 6000 Series Casting 356			Aluminum 2000, 7000 Series		Carbon and Alloy Steel AISI-410		Corrosion Resistant Steels	High Nickel and PH Steels	Copper Alloys	Miscellaneous	Titanium																													
	Joint Surface Finishes																																								
	None	MIL-C-5541 Class 1A	MIL-C-5541 Class 3	Electroless Nickel	Cadmium Plated Bare	Cadmium Colored Chromate	Cadmium Clear Chromate	Chromium	MIL-C-5541 Class 1A	MIL-C-5541 Class 3	Electroless Nickel	Cadmium Plated Bare	Cadmium Colored Chromate	Cadmium Clear Chromate	Chromium	Tin	Cadmium Bare	Cadmium Colored Chromate	Cadmium Clear Chromate	Nickel	Electroless Nickel	Chromium	Tin	Lead	Silver	Passivated	Cadmium (Passivated)	Tin	Passivated	Cadmium (Passivated)	Tin	Tin	Silver	Gold	Solder (Lead-Tin)	Silver Paint	Zinc Paint	Silver Adhesive	Carbon Adhesive	None	Nickel
<b>Aluminum</b>	A	A	A	D	A	A	A	A	A	A	D	D	A	A	A	A	A	A	A	D	D	A	A	D	X	C	A	A	C	A	A	A	X	X	A	X	X	D	D	D	D
<b>Tin Plated*</b>	A	A	A	D	A	A	A	A	A	A	D	A	A	A	A	A	A	A	A	D	D	A	A	A	A	A	A	A	A	A	A	A	A	A	A	D	A	D	D	D	D
<b>Monel</b>	C	D	D	A	D	D	D	A	D	D	A	D	D	D	A	D	D	D	D	A	A	A	A	D	A	A	D	A	A	D	A	A	D	D	A	D	D	D	D	A	A
<b>Silver Elastomer</b>	E	C	C	D	C	C	C	A	C	C	D	E	C	C	A	A	C	C	C	D	D	A	A	X	A	D	E	D	D	E	D	D	A	A	D	A	X	A	A	D	D
<b>Stainless Steel*</b>	C	C	C	A	C	A	A	A	D	C	A	D	A	A	A	A	C	A	A	A	A	A	A	D	A	A	D	A	A	D	A	A	A	A	A	A	X	A	D	A	A
<b>Beryllium Copper</b>	C	C	C	D	C	C	C	D	C	C	D	C	C	C	D	C	C	C	D	D	D	C	C	D	D	C	C	D	C	C	C	C	C	C	C	D	C	C	C	C	C

\*Standard gasket materials used by Spira.

## Legend:

- A - Compatible
- B - Requires sealing only if exposed to salt atmosphere or high humidity. Edge plating may be satisfactory
- C - Requires sealing if exposed to humid environment
- D - Compatible in environment of controlled temperature and humidity only
- E - Requires sealing regardless of exposure
- X - Not usable

## Compliance Information

Spira is a veteran owned small business, manufacturing all products in the USA. Spira’s commitment to quality is demonstrated through our ISO-9001:AS9100 certification. We are registered through QMI-SAI Global, and ANAB accredited. Spira products meet requirements of ITAR, RoHS, DFAR, and others. For more information please visit: [www.spira-emi.com/compliance](http://www.spira-emi.com/compliance).

## RoHS Compliance

As noted throughout this catalog, there are RoHS compatible options available for all tin plated Spira gaskets. The RoHS versions (with prefix IW or EIW) use pure tin plating instead of our standard tin/lead plating. The RoHS compatible tin plating has been tested for whisker growth and whisker growth was not detected. Please contact us for a copy of the test results or more information.

Spira products are protected under U.S. patents 3,502,784, 5,895,885 and 5,910,639.



# Spira Part Number Matrix

Product	Standard Force	Moderate Force	Low Force	Shield Plating	Cord/Elastomer	Notes
<b>Spira-Shield</b> • Excellent Shielding • Groove Mount • Salt-Fog Option (E)	SS-XX or IWSS ESS-XX or EIWSS No cord	MS-XX or IWMS MS-XX NC EMS-XX or EIWMS EMS-XX NC	LS-XX or IWLS LS-XX NC ELS-XX or EIWLS ELS-XX NC	TBC or EBC RoHS: IW/EIW Options: G, R, N	PVC cord Options: -F, -O, -S, -T	1,2,3,8
<b>Quick-Shield</b> • Low Cost, Moderate	NI-XX No cord	NM-XX NC NM-XX	NL-XX NC NL-XX	NI	No cord default Option: PVC	1,2,3
<b>Ultra Quick-Shield</b> • Low Cost, Excellent	TNI-XX or IWN1 No cord	TNM-XX NC TNM-XX or IWNM	TNL-XX NC TNL-XX or IWNL	TNI RoHS: IW	PVC cord	1,2,3
<b>Flexi-Shield</b> • Moderate to Excellent Shielding • Rain/Wind/Dust • VME/Sliding App	SQ-XX TSQ-XX or IWSQ ST-XX EST-XX or EIWST	MQ-XX TMQ-XX or IWMTQ MT-XX EMT-XX or EIWMT	LQ-XX TLQ-XX or IWTLQ LT-XX ELT-XX or EIWLT	NI or TNI RoHS: IW TBC or EBC RoHS: IW/EIW Option: R	Silicone Tubing Option: -F	1,2,3,4 8
<b>Enduro-Shield</b> • Excellent Shielding • Rain/Wind/Dust • 4 foot lengths	SINI-XX SISS-XX or IWSISS ESISS-XX or EIWSISS	SINM-XX SIMS-XX or IWSIMS ESIMS-XX or EIWSIMS	SINL-XX SILS-XX or IWSILS ESILS-XX or EIWSILS	NI, TBC or EBC RoHS: IW/EIW Options: R, G	Silicone Adhesive Options: -F, -O, -Z	1,2,5,8
<b>O-Rings</b> • Excellent EMI Rain/ Wind/Dust • Very Durable	SSOG-B-YYY ESSOG-B-YYY FSOG-B-YYY EFSOG-B-YYY	N/A	N/A	Enduro-Shield or Flexi-Shield TBC or EBC RoHS: IW/EIW	SSOG=Silicone Adhesive Options: -F, -O, -Z FSOG=Silicone Tube	1,2,8
<b>"D" Multi-Seal</b> • Best Groove Mount Environmental Seal	DSS-XXAB DESS-XXAB No cord	DMS-XXAB DMS-XXAB NC DEMS-XXAB DEMS-XXAB NC	N/A	Spira-Shield TBC or EBC RoHS: IW/EIW or ANY spiral	Elastomer Solid Silicone Options: /E, /F, /O	1,2,3,6 8
<b>Basic Multi-Seal</b> • Excellent Shielding • Best Surface Mount Environmental Seal	CSS-XXAB CESS-XXAB No cord	CMS-XXAB CMS-XXAB NC CEMS-XXAB CEMS-XXAB NC	CLS-XXAB CLS-XXAB NC CELS-XXAB CELS-XXAB NC	Spira-Shield TBC or EBC RoHS: IW/EIW or ANY spiral	Elastomer Solid Silicone Options: /E, /F, /O	1,2,3,6 8
<b>Quick-Strip</b> • Moderate to Excellent Shielding • Peel-n-Stick	NI-XXAB-A /P TNI-XXAB-A /P No cord	NM-XXAB-A /P NM-XXAB-A NC /P TNM-XXAB-A /P TNM-XXAB-A NC /P	NL-XXAB-A /P NL-XXAB-A NC /P TNL-XXAB-A /P TNL-XXAB-A NC /P	Quick or Ultra Quick-Shield NI, TNI or IW or ANY spiral	Elastomer /P=Neoprene Sponge Options: /C	1,2,3,6 8
<b>Spira-Strip</b> • Excellent Shielding • Surface Mount • Environmental Seal	SS-XXAB /S ESS-XXAB /S No cord	MS-XXAB /S MS-XXAB NC /S EMS-XXAB /S EMS-XXAB NC /S	LS-XXAB /S LS-XXAB NC /S ELS-XXAB /S ELS-XXAB NC /S	Spira-Shield TBC or EBC RoHS: IW/EIW or ANY spiral	Elastomer /S=Solid Silicone Options: /E, /F, /O	1,2,3,6 8
<b>Environmental- Only Connector-Seal</b>	EOCS-ZZ /S or /F No EMI gasket	N/A	N/A	N/A		7,8
<b>EMI/Environmental Connector-Seal</b> • Excellent EMI & Seal • Back or Front Mount	ECS-T-ZZ /S or /F or -E, -IW or -EIW <b>Front-Mount:</b> FMECS-T-ZZ /S or /F	N/A	N/A	Spira-Shield TBC: -T, EBC:-E RoHS: -IW/EIW	Frame /S: Silicone over Stainless Steel /F: Fluorosilicone over Stainless Steel	2,7,8
<b>EMI-Only Connector-Seal</b> • Replaces SSCG	CS-T-ZZ /S or /F or -E, -IW or -EIW	N/A	N/A	Spira-Shield TBC: -T, EBC:-E RoHS: -IW/EIW		2,7,8

## Notes:

- Spiral Gasket Measurement:** XX= spiral diameter, XX/64 in inches. Ex: SS-04, 04/64 = .0625"  
Compression Forces are: Standard (~30 lbs/in), Moderate (~10 lbs/in) or Low (~1.5 lbs/in)
- Spiral Plating:** TBC = tin/lead plated beryllium copper, EBC = edge tin/lead plated beryllium copper, NI = Stainless Steel, TNI = Tin/lead plated Stainless Steel. For **RoHS** add an IW prefix for pure tin plating or EIW for edge tin plating. Special Plating can be specified with a letter in front of the part number. R = Reflow EBC, G = Gold, N = Sulfamate Nickel. Ex: RMS-11 for Reflow edge plated MS-11. Gold and Reflow are plated in a continuous strip.
- Cord** is PVC by default for Moderate and Low Force gaskets. NC=No cord. (No cord by default for Standard Force)  
Special Cord can be specified after the part number: -S = Solid Silicone, -F = Solid Fluorosilicone, -O = Space Qualified Silicone (non-outgassing), -T = Thermal Plastic Rubber. Ex: IWMS-08-S for RoHS tin plating, solid silicone cord.
- Flexi-Shield Plating** is NI (LQ, MQ, SQ); TNI (TLQ, TMQ, TSQ); TBC (LT, MT, ST); EBC (ELT, EMT, EST) or add IW/EIW for RoHS.
- Enduro-Shield Plating** is NI (SINI, SINM, SINL); TBC (SISS, SIMS, SILS); EBC (ESISS, ESIMS, ESILS) or add IW/EIW for RoHS. Adhesive is Silicone Impregnated; Sizes up to -.09. Special Adhesive can be specified: -F = DC730 Fluorosilicone, -O = DC61104 Space Qualified (non-outgassing), -Z = DC3145 Non-acetic acid base. Ex: SILS-09-Z
- Strip Gasket Measurement:** XX= spiral diameter; A/32 = thickness of elastomer, B/8 = width of elastomer (in inches). Any spiral gasket can be specified as desired. Strip Elastomer can be specified: /S = Solid Silicone, /F = Fluorosilicone, /O = Space Qualified Silicone (non-outgassing), /E = EPDM, /P = Neoprene Sponge, /C = Silicone Sponge, -A adhesive backing. Ex: MS-0623 NC /F
- Connector-Seal Gaskets:** ZZ specifies sizing. Refer to the product part number tables as each product has different sizing.
- Special Options:** Please note that many options listed are custom and will require additional time and charges.